



Installation and Operating Instructions

Models:

HO-4-6S-CER-T

HO-4-6NF-CER-T

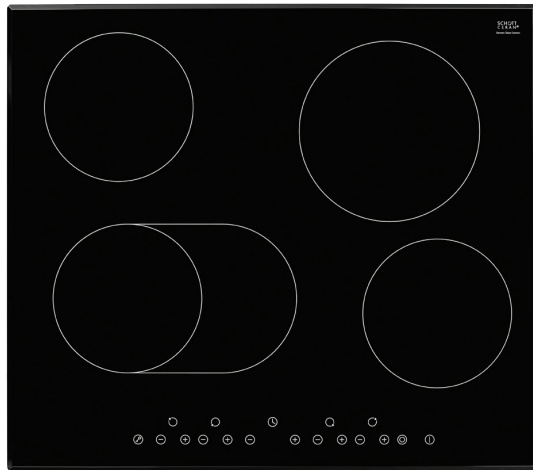

For your convenience, we recommend to attach
the serial number label HERE.

As part of Parmco Appliances commitment to improving and updating product ranges,
we reserve the right to alter, change and update technical specifications and appearance
attributes of all Parmco Appliances products. E&OE

727626042013



Dear Valued Customer,

Thank you and congratulations on purchasing your new Parmco appliance.

All Parmco products are made to the highest quality and design standards. We are sure you will enjoy your new appliance.

As a note, please read through these instructions carefully, as these will assist you in gaining a complete understanding of the functions and features offered by your appliance.

Please take special note of all detailed technical information and installation instructions. It is essential that you only allow a qualified technician to install this appliance to ensure the safety and reliability of this appliance.

Furthermore, not using appropriate personnel to install this appliance may affect any future warranty claims lodged, so please check with Parmco Appliances before any installation is carried out.

We hope you enjoy your new appliance. If you would like to find out more about this product or any other products in Parmco's extensive range, visit us on the web at www.parmco.co.nz.

Regards,
The Parmco Team



Safety Warnings

1. If the supply cord is damaged, it must be replaced by the manufacturer, its service agent or similarly qualified persons.
2. This product is intended for indoor use only.
3. Power line connection: The power cord should be connected in compliance with the relevant New Zealand standard, to an 3x20A omni-polar circuit breaker.
4. If the appliance is being connected directly to the mains an Omni-polar circuit-breaker must be installed with a minimum opening of 3mm between contacts.
5. Please use a dedicated power protection switch.
6. Do not wash the induction hotplate directly with water. Excess water entering the hob is a hazard.
7. Never have the induction hotplate working without food or liquid within the cooking vessel as this will affect its operational performance and may damage the unit.
8. Do not heat unopened canned goods directly on the induction hob as there is a danger of explosion due to heat expansion.
9. After being used for a long time, the corresponding heating zone of the induction hotplate will be hot. Do not touch the ceramic surface to avoid personal injury.
10. We suggest that you should periodically check that there are no objects (glass, paper, etc) that could obstruct the ventilation inlets under your induction hotplate.

11. Metallic objects such as knives, forks, spoons and lids should not be placed on the hotplate since they will get hot.
12. If the surface is cracked, switch off the appliance and contact Parmco Appliances. To avoid the possibility of electric shock do not continue to use a damaged hob.
13. This appliance is not intended for use by persons (including children) with reduced physical, sensory or mental capabilities, or lack of experience and knowledge unless they have been given supervision or instruction concerning use of the appliance by a person responsible for their safety.
14. Children should be supervised to ensure that they do not play with the appliance.
15. **WARNING:** Accessible parts may become hot during use. Young children should be kept away.
16. This appliance is not intended to be operated by means of an external timer or separate remote-control system.
17. Do not clean this appliance using steam cleaners.
18. After use switch off the hob element at its control. The pan detector cannot be relied on as a means to ensure the element is turned off as other metallic objects on the element will activate the power.

Safety

This hob was specially designed for domestic use.

In our constant search to improve our products, we reserve the right to modify any technical, program, or aesthetic aspects of the appliance at any time.

- **Excessive Heat Protection**

Sensors mounted in the hob itself monitor the temperature on each hotplate. Should excessive heat occur under any circumstances, your ceramic hob will automatically disconnect the elements and cease the power supply.

- **Residual Heat Warning**

After using the hob, residual heat remains for some time while the hob cools. The letter **H+** will display to warn of heat still being emitted.

- **Auto Shutdown**

The auto shutdown is a safety feature that initiates when you forget to switch off a cooking zone. The default shutdown times are shown in the table below:

Power level	1	2	3	4	5	6	7	8	9
Default working timer (hour)	8	8	8	4	4	4	2	2	2

Installation

Selection of Installation Equipment

Cut out a hole in the table surface according to the sizes shown in the diagram. For the purpose of installation and use, a minimum of 50mm space must be preserved around the hole.

Be sure the thickness of the table surface is at least 30mm. Please select heat-resistant table material to avoid larger deformation caused by the heat radiation from the hotplate.

As shown in Figure (1).

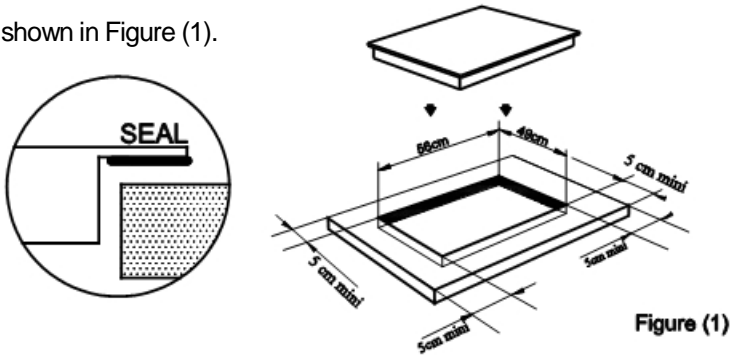

Make sure the hob is well ventilated and that there are no obstructions between the hob and the ventilation system.

Upon installation, inspect your hob to ensure it is in good working state.

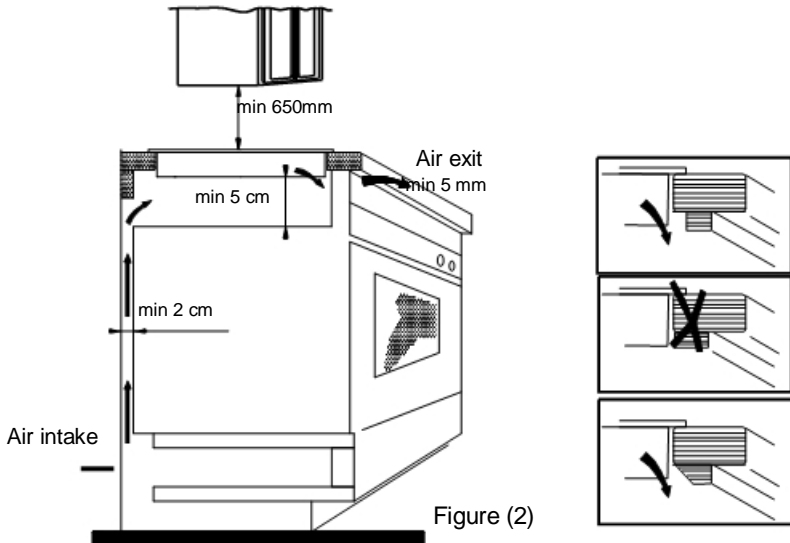

Note: The safety distance between the ceramic hob and the ventilation system should be at least 650mm. When installing the hob over drawers, a board must be installed 10mm underneath the hob. The board must be made of suitable heat resistant properties.

Fix the hob to the mounting point with the screws and brackets provided. Adjust the bracket position to suit for different table top thickness.

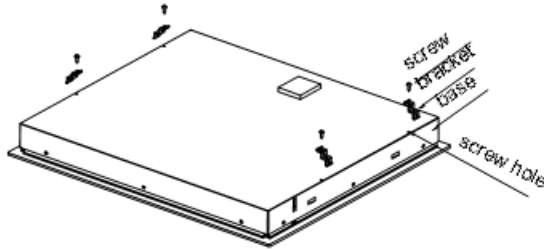

Cautions

1. Do not attempt to install this hob yourself. This hob is only to be installed by a qualified technician.
2. Do not install this hob near or on cooling appliances such as dishwashers or dryers.
3. All areas exposed directly to the hob during its operation must be made of heat resistant materials to avoid damage.
4. All adhesives used when mounting the hob must contain heat resistant properties.
5. Use only approved cleaners to clean this hob.
6. Do not clean the hob with any kind of steam cleaner.
7. To avoid a hazard, under bench access must be restricted. Installation of the board underneath the hob must be made of suitable heat resistant materials.

Power Line Connection

The socket should be connected according to the relevant standards or connected to a single-pole cut-out. The method of connection is shown in Figure (3).

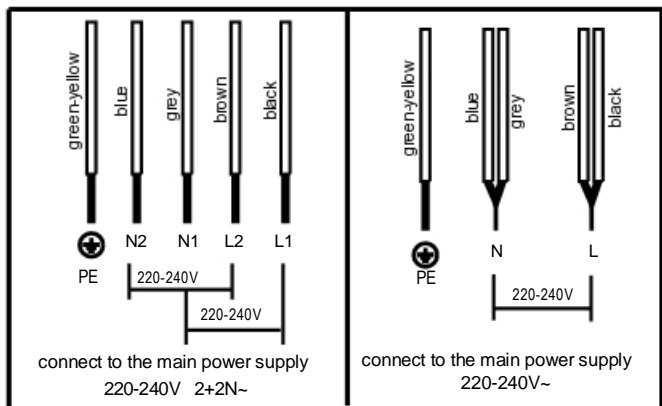
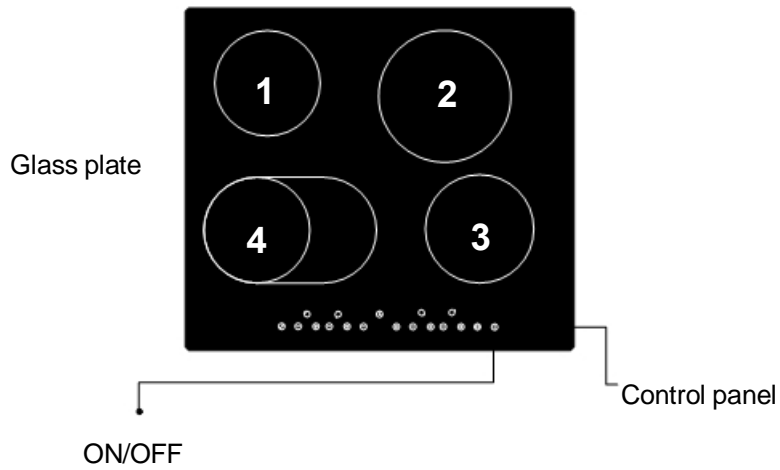

Figure (3)

- If the power cable is damaged, cease using the appliance immediately.
- If the hob is connected directly to the mains, an omnipolar circuit breaker must be installed with a minimum opening of 3mm between contacts.
- The hob must be installed in compliance with all relevant New Zealand standards.
- The cable must not be bent or compressed.
- The cable must be checked regularly and only replaced by a qualified technician.

The Ceramic Hob Appearance



Schematic Diagram of the Control Panel

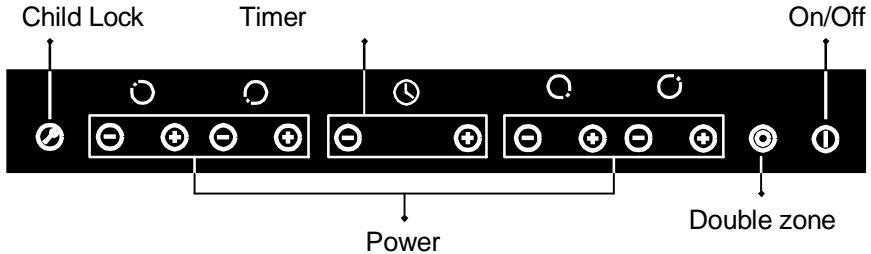

Instructions for Use

Preparation before using

When the power is switched on, the alarm will sound once, all the indicator lights will turn on for one second. Once the lights have gone out, the hob is active and in standby mode. Place the pan in the centre of the cooking zone.

Press the %**1**+key to turn on the hob. When the power indicators show %**+** and when the timer indicators show %**+**, it signifies the hob is ready for cooking. Press the %**-**+ or %**+**+key for the corresponding cooking zone to start cooking, making sure there is a pan on it. The corresponding cooking zone indicator will flash %**+** for five seconds, while the other indicators will display %**+**. Select the power level by pressing the %**-**+ or %**+**+key for the relevant hotplate.

Note:

1. When the %**1**+key is pressed, the hob returns to standby mode if no other operation is carried out within one minute.
2. Every cooking zone is independent of each other.

Double zone function

The hob is fitted with double zone

Activate the double zone

If you want to use the bigger cooking zone, press %**⊕**+ when the hob is in operation mode.

Deactivate the double zone

Press the %**⊖**+key when the hob is working with double zone.





Note:

1. This function is available only in the front left cooking zone.
2. You can select the function from power level 1 to level 9.

- When the cooking zone is in double zone working mode, the double zone indicator will show .
- You can select the size of the cooking zone according to the size of the pot.





Timer function

Cooking timer



First select the cooking zone by pressing the  or  of the relevant cooking zone. Adjust the timer by pressing  or  on the timer. The timer is confirmed after the timer indicator flashes for 5 seconds. A red dot will display on the corresponding cooking zone indicator, reminding you that a cooking timer has been assigned on this cooking zone. When the cooking timer expires, the corresponding cooking zone will be switched off automatically.

Note: The cooking timer only works for one cooking zone at one time.

Minute reminder

The timer can be used as a minute reminder. Press  or  on the timer, and the timer indicator will flash. Adjust the timer by pressing  or  on the timer. When the time is set, the timer indicator will flash for 5 seconds as confirmation, and the minute reminder will start. When the time is up, the alarm will beep for 30 seconds and the timer indicator will display . The working state of the cooking zone will not be affected by the minute reminder.



Timer cancellation

To cancel the timer, press  and  of the timer simultaneously. The timer indicator will display shows .

Lock Function

For the safety of children, the hob is fitted with a child lock device.

Activate the lock function

Press the  +key to go into lock mode. The timer display will show  and the rest of the keys are disabled except the ON/OFF keys.

Deactivating the lock function

Hold down the  +key for several seconds and the hob will return to normal operation.

The power of each cooking zone is shown in the table below.

Cooking zone	1	2	3	4	
				Inner	Double
Power	1200W	1800W	1200W	1100W	2000W

Safety and Maintenance



A dedicated power protection airswitch must be used.



Never use the ceramic hob in high temperature environments such as near a gas or kerosene stove.



Do not put any detergents or flammable materials in the equipment installed under the ceramic hob.



Metallic objects such as knives, forks, spoons and lids should not be placed on the hob as they can get hot.



For sealed foods such as canned goods, do not heat them before opening to avoid dangers of explosion.



If the supply cord is damaged, it must be replaced by a service agent or a similarly qualified person.



Do not place rough or uneven appliances on the hob. They can damage the ceramic surface.



If the surface is cracked, switch off the appliance to avoid the possibility of electric shock.



Never wash the induction cooker with water directly to avoid danger.



Do not cook on the hob without food or liquid inside the pots/pot as this may affect the hob's performance.



After use, residual heat will remain on the corresponding cooking zone. Do not touch the ceramic surface to avoid burning.



Keep the appliance out of reach of children or infirm person. Do not let them use the appliance without supervision.



DISPOSAL: Do not dispose this product as unsorted municipal waste. Collection of such waste separately for special treatment is necessary.

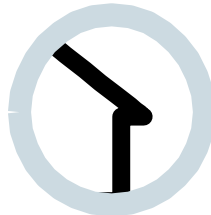

Indoor use only.

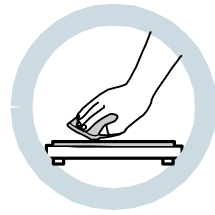

Maintain a regular cleaning routine to ensure best performance. Failure to do so will result in reduced performance and possible damage.

Cleaning and Maintenance

Type of contamination	Method of cleaning	Articles used for cleaning
Light	Clean with hot water and a damp sponge.	Cleaning sponge
Accumulation of dirt	Clean with hot water and an abrasive sponge.	Special cleaning sponge for ceramic glass
Rings and lime crumbles	Apply white vinegar to the polluted zone, then wipe it dry with a soft cloth or a special article available in local supermarkets.	Special adhesive for ceramic glass
Sweetmeat, melt aluminium, or plastics	Use a scraper suitable for ceramic glass (to protect the glass, a silicon product is preferred) to remove the residuals.	Special adhesive for ceramic glass

- A steam cleaner must not be used.
- Switch off the hob element by its control after use and do not rely on the pan detector.
- The appliance is not intended to be operated by means of an external timer or separate remote control system.



Parmco Appliances extended 5 year warranty



The Warranty:

- Subject to the terms and conditions contained within this warranty, if the product is not of Acceptable Quality (as defined in the Consumer Guarantees Act) within 5 years of the date of original purchase, then Parmco Sales undertakes to repair or, at its sole discretion, replace the product.
- The warranty does not cover the costs of transport, mileage or travelling time if the product is located beyond 30km of a recognised Service Agent.
- This warranty is offered as an extra benefit, and does not affect other legal rights, which can not be modified or excluded by agreement.
- This warranty only applies to goods supplied and installed in the North and South Islands of New Zealand.
- The provisions of this warranty are in addition to the rights and remedies available to consumers under the Consumer Guarantees Act 1993.

The Warranty is not valid:

- If the product is not installed and operated in accordance with the operating instructions.
- If the product is not installed to comply with the electrical, gas, plumbing and other Regulations and Codes of Practice in New Zealand.
- If the product is operated on voltages or frequencies outside the normal range for domestic appliances in New Zealand.
- If the product is not used in normal domestic use, or if it is used in a business as defined in the Consumer Guarantees Act.
- If any serial number has been removed or defaced.
- If proof of date of purchase is not supplied, except at the sole discretion of Parmco Sales. Proof of purchase can be for the product itself, or if installed with a kitchen or house then proof of purchase can be from a Parmco reseller of products supplied by Parmco.

Liability under this warranty will not be accepted for:

- Wear and tear from normal domestic use.
- Damage in transport.
- Damage caused to the product by neglect, abuse, negligence, wilful act or misuse.
- Any defect caused by accident, misuse, neglect, tampering with or unauthorised modifications of the appliance or any attempt at internal adjustment or repair by any person other than an Authorised Service Agent.
- Service calls that relate principally to the following:
 - Instruction on how to use the product.
 - Repair or replacement of house fuses, electrical wiring, gas fitting or plumbing.
- Wear and tear caused by normal use of the product.
- Normal or scheduled maintenance including blocked filters or ducting.
- Consumable items such as light bulbs.
- Any damage to ceramic glass hobs caused by spills when cooking.
- Any breakage or damage of glass items.
- Any damage caused by non recommended product used for cleaning, maintaining, lubricating or similar.
- Any aspect relating to the installation of the product, or damage caused during installation.
- Any third party (including reseller) or consequential loss or damage (direct or indirect) however arising.

Product _____ Date of purchase _____

Dealer / Retailers Name _____

Please retain this Warranty card together with receipt or other proof of purchase date when seeking service during the warranty period

Please contact Parmco at 09 573 5678 if your appliance needs servicing under warranty. Please have your model number and proof of purchase ready. Warranty repairs must be authorized by Parmco.