

Installation and Operating Instructions

Model:

**HO33BC2, HO36AC4, HO36BC4,
HO16AC4, HO16BC4,
HO377BC4, HO39BC5**

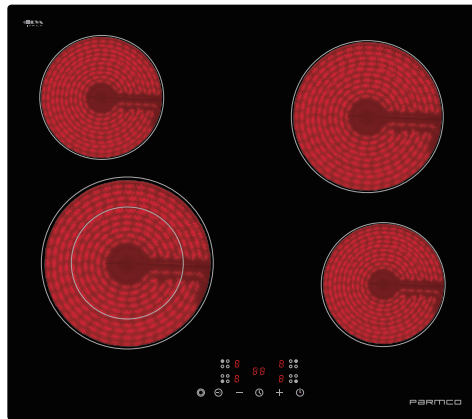

For your convenience, we recommend to attach
the serial number label **HERE**.

As part of Parmco Appliances commitment to improving and updating product ranges, we reserve the right to alter, change and update technical specifications and appearance attributes of all Parmco Appliances products. E&OE

11092024

PARMCO

Inspiring kitchens, entertaining homes

p: 09 573 5678
f: 09 573 5699
e: sales@parmco.co.nz
w: www.parmco.co.nz

Parmco Appliances extended 7 year warranty

The Warranty:

- This appliance is intended for domestic use in the owners' home. Use of the appliance for commercial purposes will limit the warranty period (please see Parmco website for commercial details).
- Subject to the terms and conditions contained within this warranty, if the product is not of Acceptable Quality (as defined in the Consumer Guarantees Act) within 7 years of the date of original purchase, then Parmco Sales undertakes to repair or, at its sole discretion, replace the product.
- The warranty does not cover the costs of transport, mileage or travelling time if the product is located beyond 30km of a recognised Service Agent.
- This warranty is offered as an extra benefit, and does not affect other legal rights, which can not be modified or excluded by agreement.
- This warranty only applies to goods supplied and installed in the North and South Islands of New Zealand.
- The provisions of this warranty are in addition to the rights and remedies available to consumers under the Consumer Guarantees Act 1993.

Product _____ Date of purchase _____
Serial Number _____
Dealer / Retailers Name _____

Please retain this Warranty card together with receipt or other proof of purchase date when seeking service during the warranty period

Please contact Parmco at 09 573 5678 if your appliance needs servicing under warranty. Please have your model number and proof of purchase ready. Warranty repairs must be authorized by Parmco.



The Warranty is not valid:

- If the product is not installed and operated in accordance with the operating instructions.
- If the product is not installed to comply with the electrical, gas, plumbing and other Regulations and Codes of Practice in New Zealand.
- If the product is operated on voltages or frequencies outside the normal range for domestic appliances in New Zealand.
- If the product is not used in normal domestic use, or if it is used in a business as defined in the Consumer Guarantees Act.
- If any serial number has been removed or defaced.
- If proof of date of purchase is not supplied, except at the sole discretion of Parmco Sales. Proof of purchase can be for the product itself, or if installed with a kitchen or house then proof of purchase can be from a Parmco reseller of products supplied by Parmco.
- If the products are purchased in a second hand condition from other parties (including but not limited to TradeMe, Sella, etc.)

Liability under this warranty will not be accepted for:

- Wear and tear caused by normal domestic use of the product.
- Damage in transport.
- Damage caused to the product by neglect, abuse, negligence, wilful act or misuse.
- Any costs associated with the repair, replacement, removal or reinstallation of products installed in a damaged condition.
- Any defect caused by accident, misuse, neglect, tampering with or unauthorised modifications of the appliance or any attempt at internal adjustment or repair by any person other than an Authorised Service Agent.
- Service calls that relate principally to the following:
 - Instruction on how to use the product.
 - Repair or replacement of house fuses, electrical wiring, gas fitting or plumbing.
 - Normal or scheduled maintenance including blocked filters or ducting.
 - Consumable items such as light bulbs.
 - Any damage to hobs caused by spills when cooking.
 - Any breakage or damage of glass items.
 - Any damage caused by non recommended product used for cleaning, maintaining, lubricating or similar.
- Any aspect relating to the installation of the product, or damage caused during installation including blocked access for repair.
- Any third party (including reseller) or consequential loss or damage (direct or indirect) however arising.

Subject to updates without prior notice, please visit www.parmco.co.nz for the latest version.

E & O.E. 727626092020



Dear Valued Customer,

Thank you and congratulations on purchasing your new Parmco appliance.

All Parmco products are made to the highest quality and design standards. We are sure you will enjoy your new appliance.

As a note, please read through these instructions carefully. These will assist you in gaining a complete understanding of the functions and features offered by your appliance. Please take special note of all detailed technical information and installation instructions. It is essential that you follow these instructions to ensure the safety and reliability of this appliance.

Furthermore, not using appropriate personnel to install this appliance may affect any future warranty claims lodged, so please check with Parmco Appliances before any installation is carried out.

We hope you enjoy your new appliance. If you would like to find out more about this product or any other products in Parmco's extensive range, visit us online at www.parmco.co.nz.

Regards,
The Parmco Team

PARMCO

Inspiring kitchens, entertaining homes

INDEX

SAFETY WARNINGS	4
INSTALLMENT	11
GUIDE TO THE APPLIANCE.....	17
CARE AND CLEANING.....	29
QUESTION AND QUICK CHECK	31
ERROR CODE	32
WASTE MANAGEMENT	33

Congratulations on the purchase of your new hob. We would like to thank you for purchasing a product from our wide range of domestic appliances. We recommend that you spend some time to read this Instruction / Installation Manual in order to fully understand how to install correctly and operate it. For installation, please read the installation section. Read all the safety instructions carefully before use and keep this Instruction / Installation Manual for future reference. If you transfer the appliance to a third party, also hand over this instruction manual.

- ❶ The figures in this instruction manual may differ in some details from the current design of your appliance. Nevertheless follow the instructions in such a case.
- ❷ Any modifications, which do not influence the functions of the appliance, shall remain reserved by the manufacturer. Please dispose of the packing with respect to your current local and municipal regulations.
- ❸ The appliance you have purchased may be an enhanced version of the unit this manual was printed for. Nevertheless, the functions and operating conditions are identical. This manual is therefore still valid. Technical modifications as well as misprints shall remain reserved.

1. SAFETY WARNINGS

Please read this user manual thoroughly before attempting to use this appliance for the first time. This manual contains important information on safe installation, use and care of the appliance. Keep these instructions for reference and pass them on to future user.

All information included in those pages serve for the protection of the operator. If you ignore the safety information and safety instructions, you will endanger your health and life.

Store this manual in a safe place so you can use it whenever it is needed. Strictly observe the instructions to avoid damage to persons and property.

MAKE SURE THAT THIS MANUAL IS AVAILABLE TO ANYONE USING THE APPLIANCE AND MAKE SURE THAT IT HAS BEEN READ AND UNDERSTOOD PRIOR TO USING THE APPLIANCE.

Installation

Electrical Shock Hazard

- The technical data of your energy supply must meet the data on the rating label. Disconnect the appliance from the mains electricity supply before carrying out any work or maintenance on it.
- Do not connect the appliance to the mains if the appliance itself or the power cord or the plug are visibly damaged.
- All modifications to the electrical mains to enable the installation of the appliance must be performed by a qualified professional.
- Connection to a good earth wiring system is essential and mandatory. A check-up of existing and newly-made connections must be done by an authorized professional.
- Alterations to the domestic wiring system must only be made by a qualified electrician. Do not modify the energy supply. The connection must be carried out in accordance with the current local and legal regulations.

- The room the appliance is installed in must be dry and well-ventilated. When the appliance is installed, an easy access to all control elements is required.
- Do not install the appliance near to curtains or upholstered furniture. RISK OF FIRE!
- Failure to follow this advice may result in electrical shock or death.

Cut Hazard

- Take care - panel edges are sharp.
- Failure to use caution could result in injury or cuts.

Important safety instructions

- Read these instructions carefully before installing or using this appliance.
- While unpacking, the packaging materials (polythene bags, polystyrene pieces, etc.) should be kept away from children and pets. RISK OF INJURY! CHOKING HAZARD!
- When you unpack the appliance, you should take note of the position of its components in case you have to repack and transport it at a later point of time.
- No combustible material or products should be placed on this appliance at any time.
- The appliance must be transported and installed by at least two persons.
- Please make this information available to the person responsible for installing the appliance as it could reduce your installation costs.
- In order to avoid a hazard, this appliance must be installed according to these instructions for installation.
- This appliance is to be properly installed and earthed only by a suitably qualified person.
- This appliance should be connected to a circuit which incorporates an isolating switch providing full disconnection from the power supply.
- The veneering of cabinets has to be fixed with a heat-resistant glue, that is able to withstand a temperature of 100 °C.
- Adjacent furniture or housing and all materials used for installation must be able to resist a temperature of min. 85 °C above the ambient temperature of the room the appliance is installed in during operation.
- Do not install the appliance in rooms or at areas which contain flammable substances as petrol, gas or paint. This warning also refers to the vapour these substances release.

- Cooker-hoods should be installed according to their manufacturers' instructions.
- The safety distance between the hob and a wall/cupboard above should be at least 450 mm.
- The safety distance between the hob and an extractor hood above should be at least 650 mm.
- Household equipment and connection leads must not touch the hob as the insulation material is usually not heat-resistant.
- Only use hob guards designed by the manufacturer of the cooking appliance or indicated by the manufacturer of the appliance in the instructions for use as suitable or hob guards incorporated in the appliance. The use of inappropriate guards can cause accidents.
- Failure to install the appliance correctly could invalidate any warranty or liability claims.

Operation and maintenance

Electrical Shock Hazard

- Never touch the power plug, the power switch or other electrical components with wet or damp hands. RISK OF ELECTRIC SHOCK!
- Operate the appliance with 220 ~ 240 V AC / 50 Hz only.
- Do not cook on a broken or cracked hob. If the hob surface is break or crack, switch the appliance off immediately at the mains power supply (wall switch) and contact a qualified technician.
- Switch the hob off at the wall before cleaning or maintenance.
- Failure to follow this advice may result in electrical shock or death.

Health Hazard

- This appliance complies with electromagnetic safety standards.

Hot Surface Hazard

- During use, accessible parts of this appliance will become hot enough to cause burns.
- Do not let your body, clothing or any item other than suitable cookware contact the ceramic glass until the surface is cool.
- Metallic objects such as knives, forks, spoons and pan lids should not be placed on the hob surface since they can get hot

- The accessible parts of the appliance become hot during operation, so keep children away. Touching the appliance while it is operating can cause serious burns.
- Handles of saucepans may be hot to touch. Check saucepan handles do not overhang other cooking zones that are on. Keep handles out of reach of children.
- The appliance will become hot while operating and will retain and emit heat even if it has stopped operating.
- Failure to follow this advice could result in burns and scalds.

Cut Hazard

- The razor-sharp blade of a hob scraper is exposed when the safety cover is retracted. Use with extreme care and always store safely and out of reach of children.
- Failure to use caution could result in injury or cuts.

Important safety instructions

- Only use cookware which is suitable to be used on ceramic glass; otherwise you will damage the appliance.
- Do not switch on the hob before you have put a cookware on it.
- Do not operate the appliance unless all components are installed properly.
- The hob should be clean at every time. Soiled cooking zones do not transfer the heat correctly.
- Protect the hob against corrosion.
- Never try to repair the appliance yourself. Repairs carried out by unauthorized persons can cause serious damage. If the appliance does not operate properly, please contact the shop you purchased the appliance at. Original spare parts should be used only.
- When you move the appliance, hold it at its base and lift it carefully. Keep the appliance in an upright position.
- Never leave the appliance unattended when in use. Boilover causes smoking and greasy spillovers that may ignite. NEVER try to extinguish a fire with water, but switch off the appliance and then cover flame e.g. with a lid or a fire blanket.
- Never use your appliance as a work or storage surface.
- Never leave any objects or utensils on the appliance.
- Never use your appliance for warming or heating the room.

- After use, always turn off the cooking zones and the hob as described in this manual (i.e. by using the touch controls).
- Do not allow children to play with the appliance or sit, stand, or climb on it.
- Do not store items of interest to children in cabinets above the appliance. Children climbing on the hob could be seriously injured.
- Always supervise children when they are near the appliance.
- Only allow children to use the appliance without supervision, when adequate instructions have been given before so that the child is able to use the appliance in a safe way and understands the risks of improper use.
- Do not leave children alone or unattended in the area where the appliance is in use.
- Children or persons with a disability which limits their ability to use the appliance should have a responsible and competent person to instruct them in its use. The instructor should be satisfied that they can use the appliance without danger to themselves or their surroundings.
- Do not repair or replace any part of the appliance unless specifically recommended in the manual. All other servicing should be done by a qualified technician.
- Do not allow anybody who is not familiar with this instruction manual to operate the appliance.
- Do not use a steam cleaner to clean your hob. The steam will cause serious damage to the electric components of the appliance. **RISK OF ELECTRICAL SHOCK!**
- Do not place or drop heavy objects on your hob.
- Do not stand on your hob.
- Do not use pans with jagged edges or drag pans across the glass surface as this can scratch the glass.
- Do not use scourers or any other harsh abrasive cleaning agents to clean your hob, as these can scratch the surface and damage the ceramic glass.
- If the supply cord is damaged, it must be replaced by the manufacturer or an authorized aftersales service or a qualified professional only, its service agent or similarly qualified persons in order to avoid a hazard. The appliance is intended for private use only.

- This appliance is intended to be used in a domestic household environment only! Commercial use of any kind is not covered under the manufacturer's warranty!
- The appliance is intended for indoor-use only.
- The appliance is not intended to be operated for commercial purposes and in public transport.
- **WARNING:** The appliance and its accessible parts become hot during use. Care should be taken to avoid touching heating elements. Children less than 8 years of age shall be kept away unless continuously supervised.
- This appliance can be used by children aged from 8 years and above and persons with reduced physical, sensory or mental capabilities or lack of experience and knowledge if they have been given supervision or instruction concerning use of the appliance in a safe way and understand the hazards involved.
- Children shall not play with the appliance. Cleaning and user maintenance shall not be made by children without supervision.
- **WARNING:** Unattended cooking on a hob with fat or oil can be dangerous and may result in fire. NEVER try to extinguish a fire with water, but switch off the appliance and then cover flame e.g. with a lid or a fire blanket.
- **WARNING:** Danger of fire: do not store items on the cooking surfaces.
- **Warning:** If the surface is cracked, switch off the appliance to avoid the possibility of electric shock, for hob surfaces of glass-ceramic or similar material which protect live parts
- A steam cleaner is not to be used.
- The appliance is not intended to be operated by means of an external timer or separate remote-control system.
- The air vents of the appliance or its built-in structure (if the appliance is suitable for being built-in) must be completely open, unblocked and free of any kind of dirt.
- In case of an event caused by a technical malfunction, disconnect the appliance from the mains. Report the malfunction to your service centre so it can be repaired.
- Do not use adapters, multiple sockets and extension cords for connecting the appliance to the mains.
- Do not carry out any modifications to your appliance.

- Switch off soiled cooking zones.
- Switch off the complete hob if any damage or malfunction occurs.
- After use, always switch off the cooking zones as described in this manual (i.e. by using the touch controls). Do not rely on the autodetection feature to switch off the cooking zones when you remove the cookware.
- The rating plate must not be removed or made illegible, otherwise all terms of the warranty become invalid!

SAVE THESE INSTRUCTIONS.

☆The manufacturer and distributor are not responsible for any damage or injury in the event of failure to comply with these instructions.

2. INSTALLMENT

Unpacking and positioning

- Unpack the appliance carefully.
- The appliance may be equipped with the transport-protection. Be very careful and do not use any aggressive or abrasive detergents to remove residuals of the transport protection.
- Check that the appliance and the power cord are not damaged.
- Connect the appliance to a dedicated socket only.
- Do not install the appliance in a place where it may come in contact with water or rain; otherwise the insulation of the electrical system will be damaged.
- Connect the appliance to the mains properly.

Selection of installation equipment

- Be sure the thickness of the work surface is at least 30mm. Please select heat-resistant work surface material to avoid larger deformation caused by the heat radiation from the hob.
- For the purpose of installation and use, a minimum of 50mm space shall be preserved around the hole.
- The safety distance between the hob and a wall cupboard above should be at least 450mm.
- The safety distance between the hob and an extractor hood above should be at least 650mm.
- Cut out the work surface according to the sizes shown in the drawing.

Models	L(mm)	W(mm)	H(mm)	D(mm)	A(mm)	B(mm)	X(mm)
HO33BC2	300	520	50	46	270	490	50 mini
HO36AC4 HO36BC4	590	520	50	46	560	490	50 mini.
HO16AC4 HO16BC4	590	520	50	46	560	490	50 mini.
HO377BC4	770	520	50	46	734	490	50 mini.
HO39BC5	900	520	50	46	830	490	50 mini.

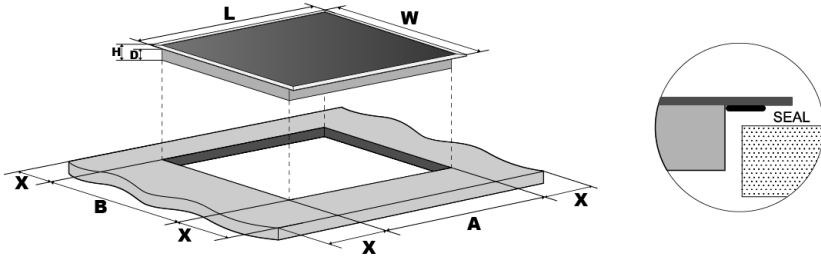

ATTENTION:

- ❶ Under any circumstances, make sure the hob is well ventilated and the air inlet and outlet are not blocked. Ensure the hob is in good work state. As shown below:
- ❷ Note: The safety distance between the hob and the cupboard above should be at least 760mm.

A (mm)	760
B (mm)	50 minimum
C (mm)	30 minimum
D	Air intake
E	Air exit 5mm

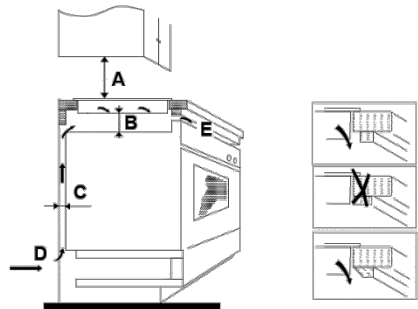

- ❹ Weight and Dimensions are approximate. Because we continually strive to improve our products, we may change specifications and designs without prior notice.

Before you install the hob, make sure that

- ❶ the work surface is square and level, and no structural members interfere with space requirements.
- ❷ the work surface is made of a heat-resistant material.
- ❸ if the hob is installed above an oven, the oven has a built-in cooling fan.
- ❹ the installation will comply with all clearance requirements and applicable standards and regulations.

- ⑤ a suitable isolating switch providing full disconnection from the mains power supply is incorporated in the permanent wiring, mounted and positioned to comply with the local wiring rules and regulations.
- ⑥ The isolating switch must be of an approved type and provide a 3 mm air gap contact separation in all poles (or in all active [phase] conductors if the local wiring rules allow for this variation of the requirements). The isolating switch will be easily accessible to the customer with the hob installed.
- ⑦ you consult local building authorities and by-laws if in doubt regarding installation.
- ⑧ you use heat-resistant and easy-to-clean finishes (such as ceramic tiles) for the wall surfaces surrounding the hob.
- ⑨ The power cable must not come into contact with cabinet doors or drawers.
- ⑩ The appliance must be supplied with an adequate flow of fresh air from outside the cabinet to the base of the hob.

Before locating the fixing brackets

The unit should be placed on a stable, smooth surface (use the packaging). Do not apply force onto the controls protruding from the hob.

Stretch out and stick the supplied tape [02] along the underside edge of the hob, ensure the ends overlap. Trim off any excess tape and dispose of it.



[02]

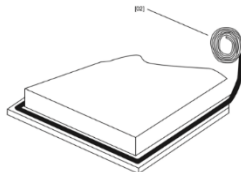

locating the fixing brackets

Fix the hob brackets by screw two brackets on the bottom of hob (see picture).

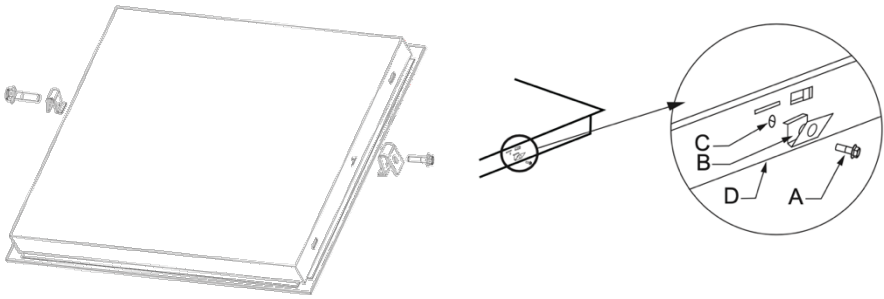

For HO39BC5, fix the hob brackets by screw four brackets on the bottom of hob (see picture).

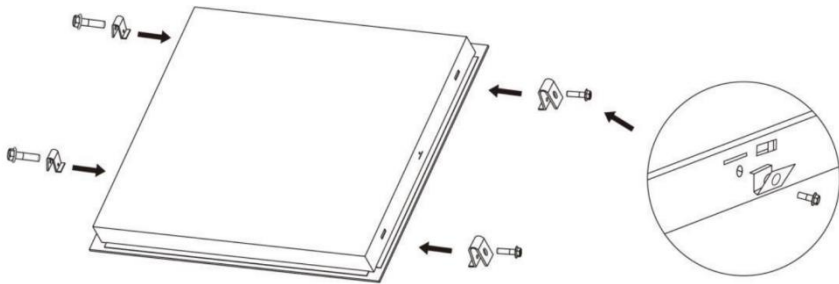

Then install the hob into the cutout of the worktop. Apply gentle downwards pressure onto the hob to push it into the worktop.

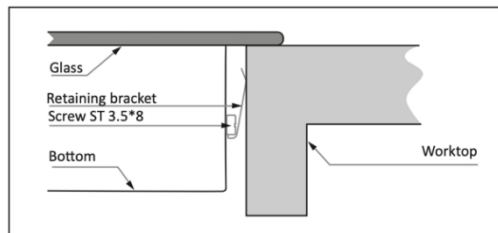

When you have installed the hob, make sure that

- ❶ the power supply cable is not accessible through cupboard doors or drawers.
- ❷ there is adequate flow of air from outside the cabinetry to the base of the hob.
- ❸ if the hob is installed above a drawer or cupboard space, a thermal protection barrier is installed below the base of the hob.
- ❹ the isolating switch is easily accessible by the customer.

Cautions

- 1 The hob must be installed by qualified personnel or technicians. We have professionals at your service. Please never conduct the operation by yourself.
- 2 The hob shall not be mounted to cooling equipment, dishwashers and rotary dryers.
- 3 The hob shall be installed such that better heat radiation can be ensured to enhance its reliability.
- 4 The wall and induced heating zone above the work surface shall withstand heat.
- 5 To avoid any damage, the sandwich layer and adhesive must be resistant to heat.
- 6 A steam cleaner is not to be used.
- 7 This hob can be connected only to a supply with system impedance no more than 0.427 ohm. In case necessary, please consult your supply authority for system impedance information.

Connecting the hob to the mains power supply

The power supply should be connected in compliance with the relevant standard, or a single-pole circuit breaker. The method of connection is shown as the diagram.

HO36AC4, HO36BC4, HO16AC4,

HO16BC4, HO377BC4, HO39BC5

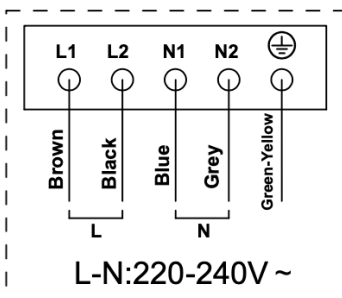

HO33BC2

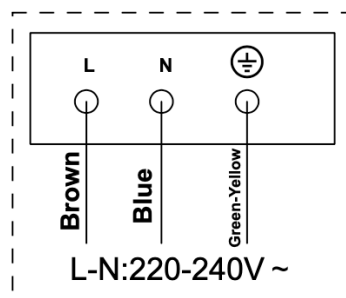



This hob must be connected to the mains power supply only by a suitably qualified person, who is familiar with and adheres to the local requirements and supplementary regulations of your electricity supplier. Do not carry out the installation yourself. **RISK OF ELECTRIC SHOCK.** Before connecting the hob to the mains power supply, check that:

- ❶ The domestic wiring system is suitable for the power drawn by the hob.
- ❷ The voltage corresponds to the value given in the rating plate
- ❸ The power supply cable sections can withstand the load specified on the rating plate.

To connect the hob to the mains power supply, do not use adapters, reducers, or branching devices, as they can cause overheating and fire.

The power supply cable must not touch any hot parts and must be positioned so that its temperature will not exceed 75°C at any point.

Check with an electrician whether the domestic wiring system is suitable without alterations. Any alterations must only be made by a qualified electrician.



1. If the cable is damaged or needs replacing, this should be done by an after-sales technician using the proper tools, so as to avoid any accidents.
2. If the appliance is being connected directly to the mains supply, an omnipolar circuit breaker must be installed with a minimum gap of 3mm between the contacts.
3. The installer must ensure that the correct electrical connection has been made and that it complies with safety regulations.
4. The cable must not be bent or compressed.
5. The cable must be checked regularly and only replaced by a proper qualified person.
6. Your household power supply must meet the power consumption of the appliance.
7. When the socket is not accessible for the user or a fixed electrical connection of the appliance is required, an all-pole disconnecting device must be incorporated during installation. Disconnecting devices are switches with a contact opening distance of at least 3 mm. These include LS-switches, fuses and protectors (EN 30335). Read the information on the nameplate and the

connection diagram before connecting the appliance to the mains. The electricity supply must be performed via a 16A automatic cut-out. If in doubt, always contact the local building authorities and consult the relevant legal provisions.

3. GUIDE TO THE APPLIANCE

HO33BC2

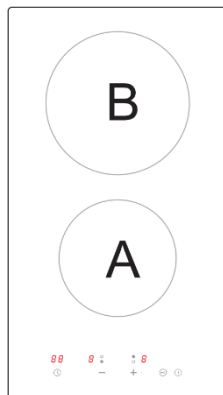

HO36AC4, HO36BC4

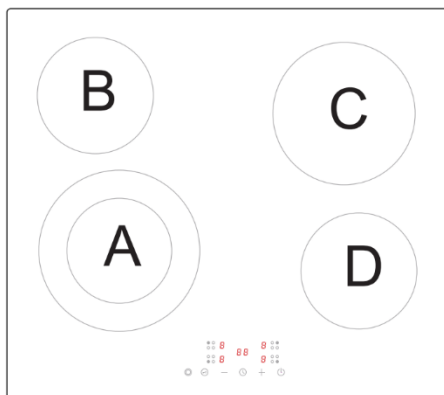

HO16AC4, HO16BC4

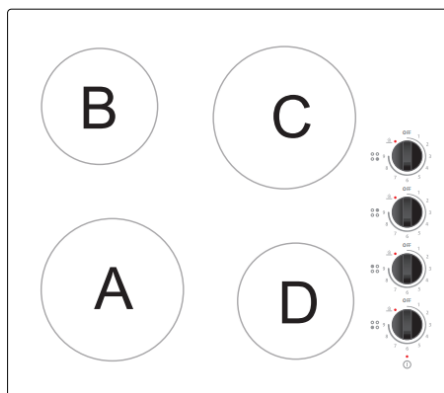

HO377BC4

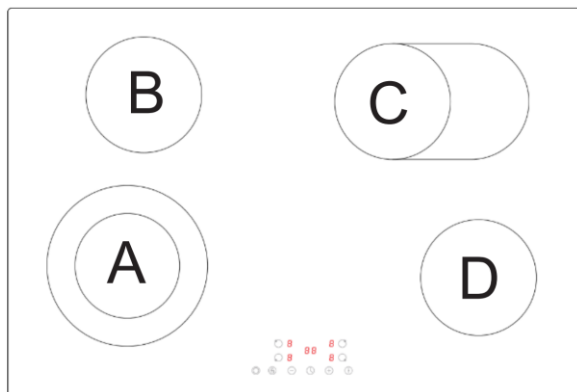

HO39BC5

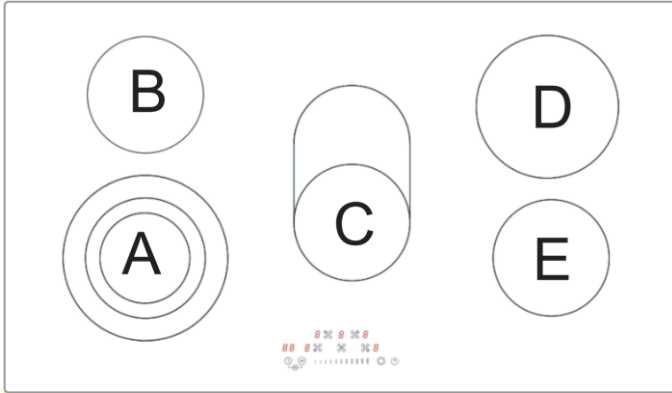

Model #	HO33BC2	HO36AC4 HO36BC4	HO16AC4 HO16BC4	HO377BC4	HO39BC5
Power of zone – A	1200W	1100/2200W	1800W	1100/2200W	800/1600/2300W
Power of zone – B	1700W	1200W	1200W	1200W	1200W
Power of zone – C	/	1800W	1800W	1100/2200W	1100/2000W
Power of zone – D	/	1200W	1200W	1200W	1800W
Power of zone – E	/	/	/	/	1200W

CONTROL PANEL

HO33BC2

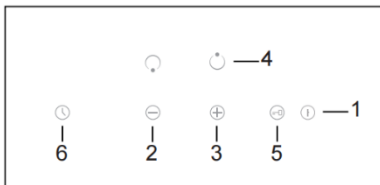

HO36AC4, HO36BC4

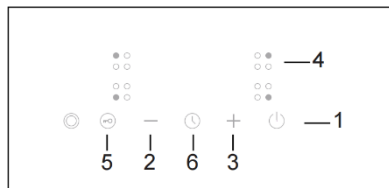

HO16AC4, HO16BC4

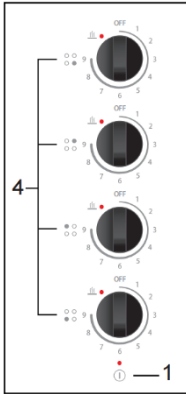

HO377BC4

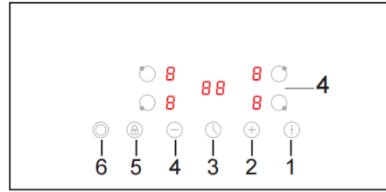

HO39BC5

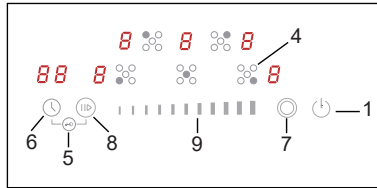

Control Panel Keys

KEY #	FUNCTIONS	KEY #	FUNCTIONS
Key 1.	ON/OFF	Key 6.	Timer
Key 2.	MINUS	Key 7.	Dual zone
Key 3.	PLUS	Key 8.	Pause
Key 4.	Zone selection /Knob	Key 9.	Slider touch
Key 5.	Child lock		

Before using your New Hob

- Read this guide, taking special note of the ‘Safety Warnings’ section.
- Remove any protective film that may still be on your hob.
- Clean the glass-ceramic

Using the Touch Controls

- The controls respond to touch, so you don’t need to apply any pressure.
- Use the ball of your finger, not its tip (see figure below).

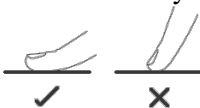

- You will hear a beep each time a touch is registered.
- Make sure the control panel is always clean, dry, and that there is no object (e.g., a utensil or a cloth) covering them. Even a thin film of water may make the controls difficult to operate.

Choosing the right Cookware

- Use glass-ceramic suitable cookware only.
- The base of cookware must have a minimum diameter relevant to the diameter of the cooking zone you use the cookware on.

Do not use cookware with jagged edges or a curved base.



Make sure that the base of your pan is smooth, sits flat against the glass, and is the same size as the cooking zone. Always center your pan on the cooking zone.

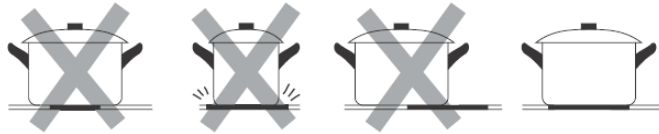

Always lift pans off the hob – do not slide, or they may scratch the glass.

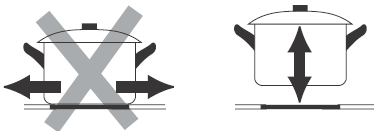

Using your Hob with touch control panel

Switching the hob on and off

Switch the hob on and off by using the main switch.

Touch the ON/OFF key (1). All the indicators show “-“. The Hob is in standby mode.

2. Place a suitable pan on the cooking zone that you wish to use.

- Make sure the bottom of the pan and the surface of the glass are clean and dry.

3. Select zone by touch corresponding zone selection key (4), an indicator next to the key will flash.

4. Select power level by touching the MINUS (2) or PLUS key (3). The power can be changed during cooking as required.

For HO39BC5, touch the Key (9) to the level you want to set.



• If you don't choose a heat setting within 1 minute, the hob will automatically switch off. You will need to start again from step 1.

5. While cooking, the power level can be changed at any time.

When you have finished cooking

1. Selecting the burner that you wish to switch off by pressing the zone selection key (4).

2. Turn the cooking zone off by touching MINUS key (2) until power level reduce to "0".

For HO39BC5, touch the Key (9) to "0".



3. To turn the whole hob off, touch the ON/OFF key (1).

4. You can use the residual heat for saving energy when starting a new cooking procedure on a cooking zone which is still warm / hot.

For HO16AC4, HO16BC4

Switching the hob on and off

1. Touch the ON/OFF key (1). The power indicator lights up. The hob is in standby mode.

2. Place a suitable pan on the cooking zone that you wish to use. Make sure the bottom of the pan and the surface of the glass are clean and dry.

3. Turn the knob that controls the cooking zone you intended to use to the power level you want to set, a zone indicator will light up.

If you don't choose a heat setting within 1 minute, the hob will automatically switch off. You will need to start again from step 1.

The hob has two step activation protection. After switching on, the hob will not start heating automatically even the knob is not in OFF position. You have to

turn it to activate the zone. Always turn the knob to OFF position when you finish the cooking.

When you have finished cooking

Turn the control knobs to “OFF” position.

Touch the ON/OFF key (1) and the power indicator disappear.

Residual Heat Warning (Beware of hot surfaces)

When the hob has been operating for some time, there will be some residual heat. The power indicator will appear “H” or red light twinkling to warn you to keep away from it.

It will disappear when the surface has cooled down to a safe temperature. It can also be used as an energy saving function if you want to heat further pans, use the cooking zone that is still hot.

Using the extendable zone (For HO36AC4, HO36BC4, HO377BC4, HO39BC5)

If your hob is equipped with an extendable zone, it can be used in the following modes:

A: Center zone – only first heating unit is turned on

B: Extended zone (Center + Outer) – Both first and second heating circuits are turned on

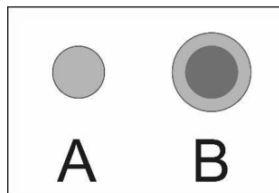

Upon selecting the cooking zone, only the center zone will be turned on, to activate the outer zone:

1. Select a cooking zone with the extendable zone function.
2. Touch the extendable zone key (7), the indicator display will show “=”

To cancel the outer zone, press the extendable zone key (7) to turn off the second heating circuit, then select the desired power level by touching the power adjusting keys.

Child Lock Function

You can use Childlock function to prevent unintended use (for example children accidentally turning the cooking zones on).

To lock the controls

Touch the Childlock key (5) until the indicator show “Lo”.

To unlock the controls

1. Make sure the hob is turned on.
2. Touch and hold the Child lock key (5) for 3 seconds.
3. You can now start using your hob.



When the hob is in Child lock mode, all the controls are disable except the main switch key, you can always turn the hob off with the main switch in an emergency, but you shall unlock the hob first in the next operation.

Auto Shutdown

Safety feature of the hob is auto shut down. This occurs whenever you forget to switch off a cooking zone. The default shutdown times are shown in the table below:

Power level	1	2	3	4	5	6	7	8	9
Default working timer (hour)	8	8	8	4	4	4	2	2	2

Using the Timer (Only for HO33BC2, HO36AC4, HO36BC4, HO377BC4, HO39BC5)

You can use the timer in two different ways:

- ❶ You can use it as a minute minder. In this case, the timer will not turn any cooking zone off when the set time is up.
- ❷ You can use it as a cut off timer to turn one or more cooking zones off when the set time is up.
- ❸ You can set the timer up to 99 minutes.

Using the Timer as a Minute Minder

1. Make sure the hob is turned on, and none cooking zone is in selecting mode.
Note: you can use the minute minder before or after cooking zone setting finished.

Touch timer key (6), “05” / “10” will show in the timer display. Then number to represent units digit will flash.

3. Set the desired minutes by touching the MINUS key (2) or PLUS key (3).

For HO39BC5, set the desired dozens of minutes by touching the Key (9).

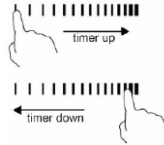

4. Touch timer key again, then number to represent tens digit will flash.

5. set the desired dozens of minutes by touching MINUS key (2) or PLUS key (3).

For HO39BC5, set the desired dozens of minutes by touching the Key (9).

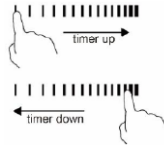

6. When the time is set, it will begin to count down immediately. The display will show the remaining time.

7. A signal sound will beeps for 10 seconds and the timer indicator shows “ - - ” when the setting time finished.

Setting the timer to turn one or more cooking zones off

If the timer is set on one zone:

1. Selecting the heating zone key (4) that you want to set timer.
2. Touch timer key (6), the digits “05” / “10” will show in the timer display.
3. Set the desired time in the control panel.
4. When the time is set, it will begin to count down immediately. The display will show the remaining time.

NOTE: The red dot next to power level indicator (eg. $6_{\times 4}$) will illuminate indicating that the zone is in timer mode.

5. When cooking timer expires, the corresponding cooking zone will be switched off automatically.



NOTE: Other cooking zones will keep operating if they are turned on previously.

If the timer is set on more than one zone:

1. When you set the time for several cooking zones simultaneously, decimal dots of the relevant cooking zones are on. The minute display shows the remaining time. The dot of the corresponding zone flashes. 

2. Once the countdown timer expires, the corresponding zone will switch off. Then it will show the remaining activated timer and the dot of corresponding zone will flash.

3. To check the remaining time set on a particular zone, touch the zone (4) and the corresponding timer will be shown in the timer indicator.

Cancel the timer

- ❶ Select the zone that you want to cancel the timer.
- ❷ 2. Touch the timer key (6), the indicator will flash.
- ❸ 3. Set the timer to "00", the timer is cancelled.

Cooking Guidelines



Take care when frying as the oil and fat heat up very quickly, particularly if you're using Power Boost. At extremely high temperatures oil and fat will ignite spontaneously and this presents a serious fire risk.



NEVER try to extinguish a fire with water, but switch off the appliance and then cover flame e.g. with a lid or a fire blanket.

Cooking Tips

- ❶ When food comes to the boil, reduce the power setting.
- ❷ Using a lid will reduce cooking times and save energy by retaining the heat.
- ❸ Minimise the amount of liquid or fat to reduce cooking times.

- ④ Start cooking on a high power and reduce it when the food has been well heated.

SIMMERING / COOKING OF RICE

- Simmering is cooking with a temperature of approx. 85 0C. At this temperature small bubbles ascend to the surface of the cooking liquid. Simmering is a perfect way to cook delicious soups and stews as the flavours of the food unfold completely without being over-heated. You should also cook egg-based sauces and sauces thickened with flour in this way.
- Some cooking procedures, including the cooking of rice with the absorption-method (= the water is consumed completely), require a setting above the lowest power level, so the food is cooked within the recommended cooking time.

STEAKS

1. Take the meat out of the fridge and let it rest at room temperature for approx. 20 minutes.
2. Heat up a pan with a heavy base.
3. Rub both sides of the steak with oil. Drizzle a small amount of oil into the hot pan and place the steak into the pan.
4. Turn the meat just once while cooking. The exact cooking time depends from the size of your steak and your individual preferences (medium, medium rare etc.). So the cooking time of each side may vary from 2 to 8 minutes. Press the steak to check the cooking result - a firm steak is well done.
5. Leave the steak on a warm plate for a few minutes; so it will become tender.

ASIAN-STYLE COOKING

1. Choose a wok with a flat base or a big pan.
2. Prepare all ingredients and the cooking utensils you need. Asian-style cooking should work fast. If you want to cook a big amount of food, you should divide the food into several portions.
3. Preheat the wok / pan briefly and add two tablespoons of oil.
4. Cook the meat first. Put it aside and keep it warm.
5. Now cook the vegetable. When the vegetable is hot but still crisp, reduce the power level. Add the meat and, if desired, a sauce.
6. Sauté the complete food carefully so all components are hot.

7. Serve immediately

Power levels

POWER LEVEL:	SUITABILITY(EXAMPLES):
Level 1-2	<ul style="list-style-type: none">• Delicate warming of small amounts of food.• Melting of chocolate, butter etc.• Food which burns quickly.• Gentle simmering.• Slow warming.
Level 3-4	<ul style="list-style-type: none">• Reheating.• Fast simmering.• Rice.
Level 5-6	<ul style="list-style-type: none">• Pancakes.
Level 7-8	<ul style="list-style-type: none">• Sautéing.• Pasta.
Level 9	<ul style="list-style-type: none">• Asian-style.• Frying.• Reaching of the boiling point of soup /water.

Saving of energy

- Use proper cookware for cooking.
- Cookware with thick, flat bases can save up to 1/3 of electric energy. Remember to cover your cookware if possible; otherwise you will use four times as much energy!
- Match the size of the cookware to the surface of the heating plate. A cookware should never be smaller than a heating plate.
- Ensure that the heating plates and the cookware are clean.
- Soils prevent heat-transfer. Repeatedly burnt-on spillages can often be removed by products, which will damage the environment, only.

- Do not uncover the cookware too often (a watched pot-content will never boil!).
- You can use the residual heat for saving energy when starting a new cooking procedure on a cooking zone which is still warm / hot.

4. CARE AND CLEANING

- Clean the hob after use.
- Clean the glass-ceramic with a commercially available detergent for glass-ceramic. Use a special sponge and warm water.
- Remove residuals on the glass-ceramic with a soft cloth.
- Do not scrub the glass-ceramic.
- Remove residuals with a silicon-made scraper, which is suitable for glass-ceramic. Such scrapers are commercial available.

What?	How?
Dirty stuff on glass (fingerprints, marks, residual stains or non-sugary spillovers on the glass).	<ol style="list-style-type: none"> 1. Switch off the power of the hob. 2. Apply a hob cleaner for glass ceramic while the glass is still warm (but not hot!) 3. Rinse and wipe dry with a clean cloth, or paper towel. 4. Switch the power to the hob back on.
Boilovers, melts, and hot sugary spills on the glass	<p>Remove these immediately with a fish slice, palette knife or razor blade scraper suitable for ceramic glass hobs, but beware of hot cooking zone surfaces which are still hot.</p> <ol style="list-style-type: none"> 1. Switch the power to the hob off at the wall. 2. Hold the blade or utensil at a 30° angle and scrape the soiling or spill to a cool area of the hob. 3. Clean the soiling or spill up with a dish cloth or paper towel. 4. Proceed as described in steps 2 - 4 in the previous section.

Spillovers on the touch controls	<ol style="list-style-type: none"> 1. Switch off the power of the hob. 2. Remove the spillovers 3. Wipe the touch control area with a clean damp sponge or cloth, then wipe the area completely dry with a paper towel. 4. Switch the power to the hob back on.
----------------------------------	---

Important!

- When the hob is switched off, there will be no ‘hot surface’ indication but the cooking zone may still be hot! Take extreme care! Disconnect the appliance from the mains before maintenance (fuse box of your household power supply)!
- Do not use a steam cleaner. Risk of electric shock! The steam can damage the electric components of the appliance.
- Heavy-duty scourers, some nylon scourers and harsh/abrasive cleaning agents may scratch the glass. Always read the label to check if your cleaner or scourer is suitable.
- Never leave cleaning residue on the hob: the glass may become stained.
- Remove stains left by melts and sugary food or spillovers as soon as possible. If left to cool on the glass, they may be difficult to remove or even permanently damage the glass surface.
- Cut hazard: when the safety cover is retracted, the blade in a scraper is razor-sharp. Use with extreme care and always store safely and out of reach of children.
- The hob may beep and turn itself off, and the touch controls may not function while there is liquid on them. Make sure you wipe the touch control area dry before turning the hob back on.

5. QUESTION AND QUICK CHECK

EMERGENCY MEASURES:

- ❶ Switch off the entire appliance.
- ❷ Disconnect the appliance from the mains (fuse box of your household power supply).
- ❸ Contact the shop you purchased the appliance at.
- ❹ Check the schedule below before you contact the shop you purchased the appliance at.

Problem	Possible causes and What to do
The hob cannot be turned on.	No power. 1. Check the connection to the power supply and make sure it is switched on. 2. Check whether there is a power outage in your home or area. 3. Check the household fuse box. 4. If you've checked everything and the problem persists, call a qualified technician
The touch controls are unresponsive.	The control panel is locked by Child lock function. Unlock the controls. See section 'Using your hob' for instructions.
The touch controls are difficult to operate.	There may be a slight film of water over the controls or you may be using the tip of your finger when touching the controls. Make sure the touch control area is dry and use the ball of your finger when touching the controls.
The glass is being scratched.	Rough-edged cookware. Unsuitable, abrasive scourer or cleaning products being used. Use cookware with flat and smooth bases. See 'Choosing the right cookware'. See 'Care and cleaning'.
Some pans make crackling or clicking noises.	This may be caused by the material of your cookware (layers of different metals vibrating differently). This is normal for cookware and does not indicate a fault.

Pans do not become hot and appears  in the display.	The induction hob cannot detect the pan. Check the pan base size, if it is too small for the cooking zone or not properly centered. Use cookware suitable for induction cooking. See section ‘Choosing the right cookware’. Centre the pan and make sure that its base matches the size of the cooking zone.
--	---

If the appliance shows a malfunction not noted on the schedule above or if you have checked all items on the above schedule but the problem still exists, please contact the shop you purchased the appliance at.

6. ERROR CODE

If an abnormality comes up, the hob will enter the protective state automatically and display corresponding protective codes:

Error Code for Ceramic hob

Problem	Possible causes	What to do
E0 & repeated beep sound warning.	Overheating protection: the hob is over heated.	Stop cooking till the internal temperature back to normal. Please contact after sales service to check the hob if there is PCB failure.
E1	Open circuit failure of thermocouple	Please contact after sales service.

The above are the judgment and inspection of common failures.

ATTENTION! To avoid danger, please do not disassemble the unit by yourself!

7. WASTE MANAGEMENT



DISPOSAL:
Do not dispose this product as unsorted municipal waste. Collection of such waste separately for special treatment is necessary. Do not remove the symbol from the appliance.

While unpacking, the packaging materials (polythene bags, polystyrene pieces, etc.) should be kept away from children and pets. **CHOKING HAZARD!**

This appliance is labeled in compliance with European directive 2002/96/EC for Waste Electrical and Electronic Equipment (WEEE). By ensuring that this appliance is disposed of correctly, you will help prevent any possible damage to the environment and to human health, which might otherwise be caused if it were disposed of in the wrong way.

The symbol on the product indicates that it may not be treated as normal household waste. It should be taken to a collection point for the recycling of electrical and electronic goods.

- Old and unused appliances must be sent for disposal to the responsible recycling centre. Never expose to open flames.
- Before you dispose of an old appliance, render it inoperative. Unplug the appliance and cut off the entire power cord. Dispose of the power cord and the plug immediately.
- Dispose of any paper and cardboard into the corresponding containers.

This appliance requires specialist waste disposal. For further information regarding the treatment, recovery and recycling of this product please contact your local council, your household waste disposal service, or the shop where you purchased it.

For more detailed information about treatment, recovery and recycling of this product, please contact your local city office, your household waste disposal service or the shop where you purchased the product.