

OV36B12

Installation and Operating Instructions

Model: OV36B12

For your convenience, we recommend to attach the serial number label HERE.

As part of Parmco Appliances commitment to improving and updating product ranges, we reserve the right to alter, change and update technical specifications and appearance attributes of all Parmco Appliances products. E&OE.

PARMCO

Inspiring kitchens, entertaining homes

p: 09 573 5678
f: 09 573 5699
e: sales@parmco.co.nz
w: www.parmco.co.nz

Parmco Appliances extended 7 year warranty



The Warranty:

- This appliance is intended for domestic use in the owners' home. Use of the appliance for commercial purposes will limit the warranty period (please see Parmco website for commercial details).
- Subject to the terms and conditions contained within this warranty, if the product is not of Acceptable Quality (as defined in the Consumer Guarantees Act) within 7 years of the date of original purchase, then Parmco Sales undertakes to repair or, at its sole discretion, replace the product.
- The warranty does not cover the costs of transport, mileage or travelling time if the product is located beyond 30km of a recognised Service Agent.
- This warranty is offered as an extra benefit, and does not affect other legal rights, which can not be modified or excluded by agreement.
- This warranty only applies to goods supplied and installed in the North and South Islands of New Zealand.
- The provisions of this warranty are in addition to the rights and remedies available to consumers under the Consumer Guarantees Act 1993.

Product _____	Date of purchase _____
Serial Number _____	
Dealer / Retailers Name _____	

Please retain this Warranty card together with receipt or other proof of purchase date when seeking service during the warranty period	

Please contact Parmco at 09 573 5678 if your appliance needs servicing under warranty. Please have your model number and proof of purchase ready. Warranty repairs must be authorized by Parmco.

The Warranty is not valid:

- If the product is not installed and operated in accordance with the operating instructions.
- If the product is not installed to comply with the electrical, gas, plumbing and other Regulations and Codes of Practice in New Zealand.
- If the product is operated on voltages or frequencies outside the normal range for domestic appliances in New Zealand.
- If the product is not used in normal domestic use, or if it is used in a business as defined in the Consumer Guarantees Act.
- If any serial number has been removed or defaced.
- If proof of date of purchase is not supplied, except at the sole discretion of Parmco Sales. Proof of purchase can be for the product itself, or if installed with a kitchen or house then proof of purchase can be from a Parmco reseller of products supplied by Parmco.
- If the products are purchased in a second hand condition from other parties (including but not limited to TradeMe, Sella, etc.)

Liability under this warranty will not be accepted for:

- Wear and tear caused by normal domestic use of the product.
- Damage in transport.
- Damage caused to the product by neglect, abuse, negligence, wilful act or misuse.
- Any costs associated with the repair, replacement, removal or reinstallation of products installed in a damaged condition.
- Any defect caused by accident, misuse, neglect, tampering with or unauthorised modifications of the appliance or any attempt at internal adjustment or repair by any person other than an Authorised Service Agent.
- Service calls that relate principally to the following:
 - Instruction on how to use the product.
 - Repair or replacement of house fuses, electrical wiring, gas fitting or plumbing.
 - Normal or scheduled maintenance including blocked filters or ducting.
 - Consumable items such as light bulbs.
 - Any damage to hobs caused by spills when cooking.
 - Any breakage or damage of glass items.
 - Any damage caused by non recommended product used for cleaning, maintaining, lubricating or similar.
- Any aspect relating to the installation of the product, or damage caused during installation including blocked access for repair.
- Any third party (including reseller) or consequential loss or damage (direct or indirect) however arising.

Subject to updates without prior notice, please visit www.parmco.co.nz for the latest version.

E & O.E. 727628042017



Dear Valued Customer,

Thank you and congratulations on purchasing your new Parmco appliance.

All Parmco products are made to the highest quality and design standards. We are sure you will enjoy your new appliance.

As a note, please read through these instructions carefully. These will assist you in gaining a complete understanding of the functions and features offered by your appliance. Please take special note of all detailed technical information and installation instructions. It is essential that you follow these instructions to ensure the safety and reliability of this appliance.

Furthermore, not using appropriate personnel to install this appliance may affect any future warranty claims lodged, so please check with Parmco Appliances before any installation is carried out.

We hope you enjoy your new appliance. If you would like to find out more about this product or any other products in Parmco's extensive range, visit us online at www.parmco.co.nz.

Regards,
The Parmco Team

PARMCO

Inspiring kitchens, entertaining homes

Content

1.....	Important safety information
2.....	Installation
3.....	Prior to start up of the appliance
4.....	Your new oven
5.....	Program and function instruction
6.....	Working mode menu
7.....	Before using the oven for the first time
8.....	How to operate the oven
9.....	Troubleshooting
10.....	Baking and grilling tips
11.....	Maintenance and cleaning
12.....	Environmental note
13.....	Test dishes

Important safety information

This User Instruction Manual contains important information, including safety & installation points, which will enable you to get the most out of your appliance. Please keep it in a safe place so that it is easily available for future reference; for you or any person not familiar with the operation of the appliance.

Warning:

- The appliance and its accessible parts become hot during use. Care should be taken to avoid touching heating elements.
- Children less than 8 years of age shall be kept away unless continuously supervised.
- This appliance can be used by children aged from 8 years and above and persons with reduced physical, sensory or mental capabilities or lack of experience and knowledge or they have been given supervision or instruction concerning use of the appliance in a safe way and understand the hazards involved. Children shall not play with the appliance. Cleaning and user maintenance shall not be made by children without supervision.
- A steam cleaner is not to be used.
- Accessible parts may become hot during use. Young children should be kept well away when in use.
- Do not use harsh abrasive cleaners or metal scrapers to clean the oven door glass as this can scratch the surface, which may result in the oven glass shattering.
- Do not use abrasive products to clean the glass door panel to avoid scratching it. Otherwise, severe failure might happen to the appliance.

- The appliance must not be installed behind a decorative door in order to avoid overheating.
- The air must not be discharged into a flue that is used for exhausting fumes from appliances burning gas or other fuels.

Operation:



Warning! Danger of fire!

- Do not allow paper or cloth to come in contact with any heating element.
- Never store or use corrosive chemicals, vapors, flammables or nonfood products in or near oven. It is specifically designed for use when heating or cooking food. The use of corrosive chemicals in heating or cleaning will damage the appliance and could result in injury
- If food inside an oven should ignite, keep door closed. Switch off the oven and disconnect from supply power.
- Exercise caution when opening the door. Standing to the side, open the door slowly and slightly to let hot air and/or steam escape. Keep your face clear of the opening and make sure there are no children or pets near the oven. After the release of hot air and/or steam, proceed with your cooking. Keep doors closed at all time

unless necessary for cooking or cleaning purposes.

- Only use utensils that are suitable for use with ovens.



Warning!

Danger of explosion!

- Liquids and other foods must not be heated in sealed containers since they are liable to explode.
- If smoke is observed, switch off the oven and keep the door closed in order to stifle any flames.
- Do not allow any accessories or electric cables to contact the hot parts of the appliance.



Warning!

Hot surfaces! Risk of burns!

- During use the appliance becomes hot. Care should be taken to avoid touching heating elements inside the oven.
- **Warning!** Accessible parts may become hot during use. Young children should be kept away.
- Never move racks or pans when they are hot. Wait until they cool.

Safety advices:



IMPORTANT!

Always switch off the electricity supply at the mains during installation and maintenance.

General Information

- This appliance is designed for domestic household use and can be built into a standard kitchen cabinet or housing unit.

- Certain types of vinyl or laminate kitchen furniture are particularly prone to heat damage or discolouration at temperatures below the guidelines given above.
- The appliance surfaces will become hot during use and retain heat after operation.
- Any damage caused by the non-compliance of temperature tolerance of oven during installation or by the too close distance between the furniture and the oven will be borne by the owner.
- This appliance is not intended for use by persons (including children) with reduced physical sensory, or mental capabilities, or by those who lack experience and knowledge, unless they have been given supervision and instruction concerning the use of the appliance by a person responsible for their safety .

Installation

- The oven must be installed in accordance with the installation instructions and all measurements must be followed.
- All installation work must be carried out by a competent person or qualified electrician.

Children

- Please dispose of the packaging material carefully. Packaging material can be dangerous to children.
- Make sure to keep children away from the appliance, children should be supervised to ensure that they do not play with the appliance. It might be dangerous to allow the children to touch the appliance.

General Safety

- Do not place heavy objects on the oven door or lean them on the oven door when it is open, as it may cause damages to the oven door hinges.
- Do not place those baked hot oil or fat unattended on unattended areas, as it will be a fire risk.
- Do not place pans or baking trays directly on the base of the oven cavity, even if aluminum foil is placed below them.
- Do not allow cable or plug to come into contact with the heating areas of appliance.
- Do not install the appliance next to curtains or soft furnishings.
- Do not attempt to lift or move cooking appliances by using the oven door or handle, as this may cause damage to the appliance or result in injury to the person lifting the appliance.

Electrical safety

- If the supply cord is damaged, it must be replaced by the manufacturer, its service agent or similarly qualified persons in order to avoid a hazard.
- The appliance must be placed in such a way, that the power supply is accessible at all times.
- Before connecting the appliance to the power supply, check that the power supply voltage and current rating corresponds with the power supply details shown on the appliance rating label.
- Never use a damaged appliance! Disconnect the appliance from the power source and contact your supplier if it is damaged.
- Danger of electric shock! Do not attempt to repair the appliance yourself.

In case of malfunction, repairs are to be conducted by qualified personnel only.

- To avoid damaging the cord, do not squeeze, bend or chafe it on sharp edges. Keep it away from hot surfaces and open flames as well.
- Lay out the cord in such a way that no unintentional pulling or tripping over it is possible.
- Do not open the appliance casing under any circumstances. Do not insert any foreign objects into the inside of the casing.
- Never use accessories which are not recommended by the manufacturer. They could pose a safety risk to the user and might damage the appliance. Only use original parts and accessories.
- Keep the appliance away from any hot surfaces and open flames. Always operate the appliance on a level, stable, clean and dry surface. Protect the appliance against heat, dust, direct sunlight, moisture, dripping and splashing water.
- Do not place objects with open flames, e.g. candles, on top of or beside the appliance.
- **WARNING:** Ensure that the appliance is switched off before replacing the lamp to avoid the possibility of electric shock.
- The fixed wiring for applicant shall have an all-pole disconnection device.



Safety:

- Attention, the glass is extremely fragile. Always wear gloves when handling.
- For your safety, this product is made of tempered glass. This type of glass is highly resistant but has the feature to retain the "memory" of shocks.

- Therefore, it should handle the product with the greatest care to avoid shocks and twists, especially during installation.
- Avoid installing this type of product in areas where it would be highly exposed to shocks.
- Do not let children play with the product.
- Do not stick adhesive film on the glass surface. In case of breakage, it would generate large pieces that could be dangerous

Electrical connection



Danger of electric shock!

- Any electrical installation must be carried out by an authorised professional.
- All fittings must be installed by a competent person in accordance with local regulations. If in doubt, consult a qualified electrician.
- Important! Always switch off the electricity supply at the mains during installation and maintenance. We recommend that the fuse is withdrawn or circuit breaker switched off at the distribution board whilst work is in progress.
- This product must be earthed – if no earth feed wire is available, consult an electrician.
- Means for disconnection must be incorporated in the fixed wiring in accordance with the wiring rules. To achieve this install appropriate switched fused connection unit.
- Note! A switched fused connection unit having a contact separation of at least 3mm in all poles should be connected in fixed wiring.

- Connect the incoming positive, neutral and earth cables to the terminals of the switched fused connection unit. Ensure connections are tight.
- The spur outlet must still be accessible even when your oven is located in its housing to enable the appliance to be disconnected from the mains supply.

Cleaning

- Always disconnect the power supply prior to cleaning the appliance. If the switched fused connection unit is difficult to reach, shut off the power supply by using the corresponding circuit breaker at the distribution board.
- Clean the appliance thoroughly before first use. The oven should be cleaned regularly and any food deposits removed.
- Never clean the oven surfaces by steam cleaning.
- The oven cavity should only be cleaned with warm soapy water, using either a sponge or soft cloth. No abrasive cleaners should be used.
- Any stains that may appear on the bottom of the oven will have originated from food splashes or spilt food, these splashes occur during the cooking process. These could possibly be a result of the food being cooked at an excessively high temperature or being placed in cookware that is too small.
- You should select a cooking temperature and function that is appropriate for the food that you are cooking. You should also ensure that the food is placed in an adequately sized dish and that you use the drip tray where appropriate.

Installation

Before installation

The appliance should be installed built in the cabinet . It should be keep safety distance with appliance and the kitchen walls. Detail pls check below picture . (values in mm).

- ✧ Surfaces, synthetic laminates and adhesives used must be heat resistant(100°C minimum), and neighboring unit fronts up to 70°C .
- ✧ Kitchen cabinets must be set level and fixed. A gap of 5 mm is required between the appliance and surrounding unit fronts.
- ✧ If there is a drawer beneath the oven, a shelf must be installed between oven and drawer.

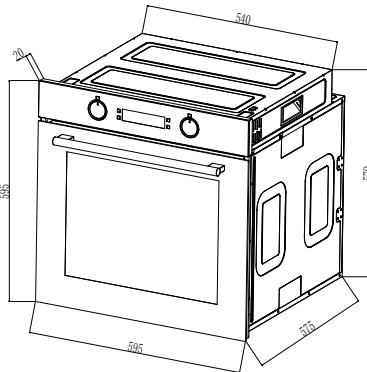
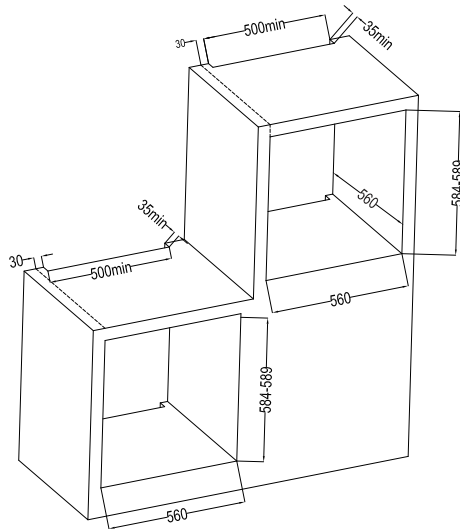

Installation method

Installation and connection

▲ Material damage!

The door and/or handle must not be used for lifting or moving the appliance.

- ✧ For installation the appliance must be connected in accordance with all local gas and/or electrical regulations.
- ✧ Carry the appliance with at least two persons.
- ✧ Use the slots or wire handles located at both sides to move the appliance.



Connection to the mains supply

This appliance must be earthed!

- ✧ Our company shall not be held responsible for any damage caused by using the appliance without an earthed socket. Risk of electric shock, short circuit or fire by unprofessional installation! The appliance may be connected to the mains supply only by an authorized qualified person and the appliance is only guaranteed after correct installation.
- ✧ Risk of electric shock, short circuit or fire by damage of the mains lead! The mains lead must not be clamped, bent or trapped or come into contact with hot parts of the appliance. If the mains lead is damaged, it must be replaced by a qualified electrician.
- ✧ The mains supply must correspond to be data specified on the rating plate of the appliance. The appliance mains cable must correspond to the specifications and the power consumption.



Risk of electric shock!

Before starting any work on the electrical installation, please disconnect the appliance from the mains supply.

Installation

1. Slide the oven through the cabinet aperture, align and secure.
2. Fix your oven with the 2 screws and washers as indicated in the figure.

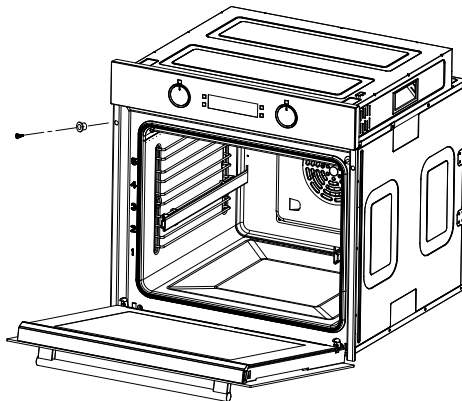

Final check

1. Connect the appliance to the mains supply and switch on the mains supply.
2. Check function.

Prior to start up of the appliance

- Once this simple operation has been carried out the oven is ready to use for cooking.
- This appliance is exclusively for domestic use.
- Use the oven to cook food only.
- Before cooking, make sure all oven accessories that are not required are removed from the oven.
- Pre-heat the oven to the cooking temperature before using it.
- Place the cooking trays in the center of oven and leave space in between when using more than one, so that the air can circulate.
- Do not put oven trays on the base of the oven or cover it with aluminium foil. This will cause thermal accumulation. The cooking and roasting times will not coincide and the enamel may be damaged.
- Try to open the oven door as little as possible to see the food (the oven light remains on during cooking).
- Take care when opening the door to avoid contact with hot parts and steam.

Your new oven

A. Oven overview

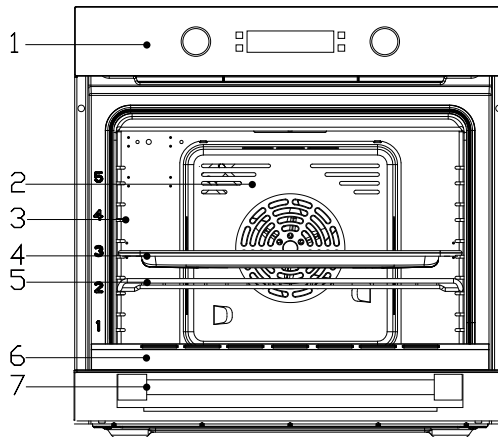

- | | |
|-----------------------------------|--------------|
| 1、 Control panel | 5、 Wire rack |
| 2、 Fan motor(behind steel plate) | 6、 Door |
| 3、 Side shelf | 7、 Handle |
| 4、 Tray | |

B. Technical specifications

Voltage/frequency	220-240V ~ 50Hz
Total power consumption	3250W
Cable type/section	H05VV-F 3*1.5mm ²
Cable length	1.2m
External dimensions(height/width/depth)	595/595/575 (mm)
Installation dimensions(height/width/depth)	600/600/ min 575 (mm)
Main oven	Multifunction oven
Energy efficiency class	A
Oven lamp	25W/300°C G9
Grill power consumption	2800W

C. Your accessories

- The accessories supplied with your appliance are suitable for making many meals. Ensure that you always insert the accessories into the cooking compartment the right way round.
- There is also a selection of optional accessories, with which you can improve on some of your favorite dishes, or simply to make working with your oven more convenient.

Inserting accessories

You can insert the accessories into the cooking compartment at 5 different levels. Always insert them as far as they will go so that the accessories do not touch the door panel.

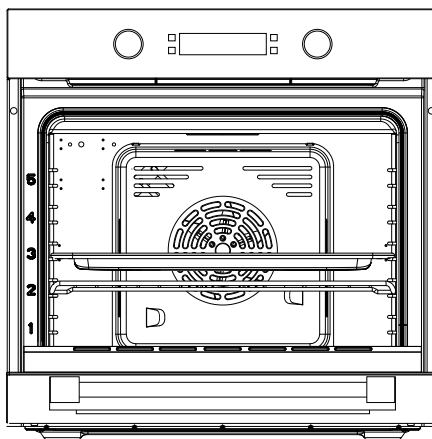

The accessories can be pulled out approximately halfway until they lock in place. This allows dishes to be removed easily.

Note: The accessories may deform when they become hot. Once they cool down again, they regain their original shape. This does not affect their operation.

Oven pan

For moist cakes, pastries, frozen meals and large roasts. It can also be used to catch dripping fat when you are grilling directly on the wire rack.

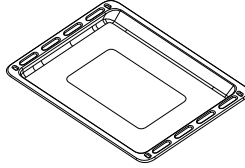

Wire rack

Used for roasting and for placing the food to be baked, roasted or cooked in casserole dishes to the desired rack.

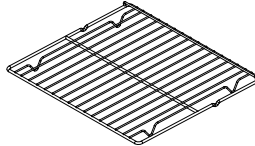

Air Fry Basket

When using the air frying function, you can use this basket to load food, it will help the cooking better and faster.

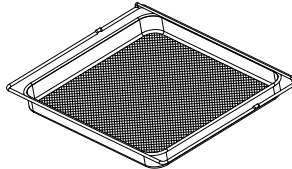

Side shelf

①②③④⑤ on behalf of five different height positions for your choosing. For removable side shelf, you can adjust four different height positions to bake food. Used for placing grills and trays which fixed to the sides of the oven cavity.

For cooking larger, these side shelf can be removed, wire rack can be put on the oven floor, using functions as grill, full grill, full grill with fan.

NOTE: When placing dishes on the oven floor, please **DO NOT** use functions with bottom heater to prevent heat gathering at bottom. **(Only for specific models)**

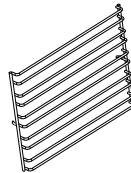

Guide sliding **(Only for specific models)**

Generally installed on the second or fourth layer of the side self, it can support the oven tray or wire rack to be pulled out and pushed smoothly, which is convenient for placing and taking out food.

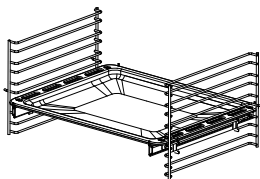

D. Control panel

Here, you will see an overview of the control panel. Depending on the appliance model, individual details may differ.

1.3.1 Button icon instruction

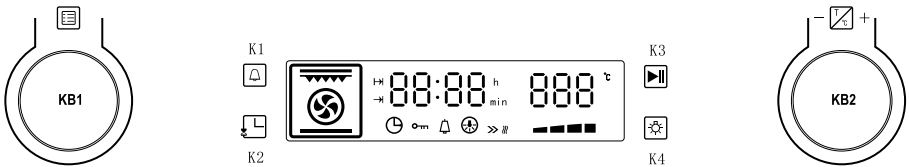

Pic 1: Buttons diagram

K1	K2	K3	K4	KB1	KB2
Reminder/Parameter switch (Temperature/Time)	Clock/Reservation	press to start/pause Press and hold for 3 seconds to cancel	Lamp	Plus/Minus (Cooking function)	Plus/Minus (Temperature/Time)

1.3.2 Display section

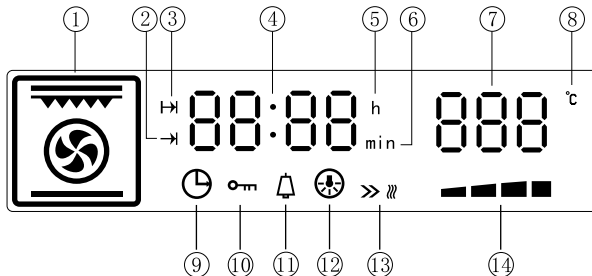





Pic 2: Display screen icon

Display screen icon instruction

Icons	Function	Icons	Function
1	Oven function	8	Unit of degree Celsius °C
2	Work time setting	9	System time
3	Reservation time setting	10	Child lock function

4	Display the day of time value	11	Clock
5	Hour	12	Lamp
6	Minute	13	Working
7	Display the temperature value	14	Working status

1.3.3 Function icon instruction

Icon	Function	Icon	Function
	Top outer heat element		Top inner heat element
	Heating fan(Defrost)		Bottom heat element
	Back heat element		

Program and function instruction

1、 Power on

- ✧ After the external power supply is connected to the oven, the display panel will light up and enter the clock setting state. At this point, clock settings can be performed. Please refer to the clock setting requirements for specific operations.
- ✧ After 10s without any operation and the oven will enter to adjust minute.
- ✧ Within 10s without any operation when adjusting minute, the oven will enter standby mode automatically.
- ✧ Under standby mode, if no any operation in 3 minutes, the oven will switch off automatically, and the display screen is not displayed.
- ✧ When the oven is switch off, you can change to standby mode by press any button or function knob KB1, and the standby mode displays the real time system clock and clock icon.(Refer to pic 3 for the display effect.)

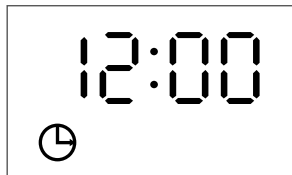

Pic 3: Initial standby mode

2、 Time setting

Under standby status, touching “” once into the clock adjustment state. At this time, you can set the hour by rotating KB2.



Pic 4: Hour adjustment display effect

- ✧ After adjusting the hour time, re-touch “” to switch to minute adjustment. Minute value will flash at this time, by rotating programming switch KB2 to set minute time.

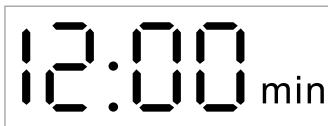

Pic 5: Minute adjustment display effect

- ✧ After adjusting the minutes, re-touch the “” key to confirm.
- ✧ If the clock setting is not confirmed within 10 seconds, the system defaults to complete the clock setting and automatically returns to standby.
- ✧ If the clock is not adjusted within 20 seconds after power on, the system defaults to 12:00 and is on standby.
- ✧ If the power is off, the clock will be readjusted.

Note: There will be only system clock displayed under standby status.

3、The choice of function

Under standby status, switch different functions by rotating the programming switch KB1 in turn, refer to picture below for the order.

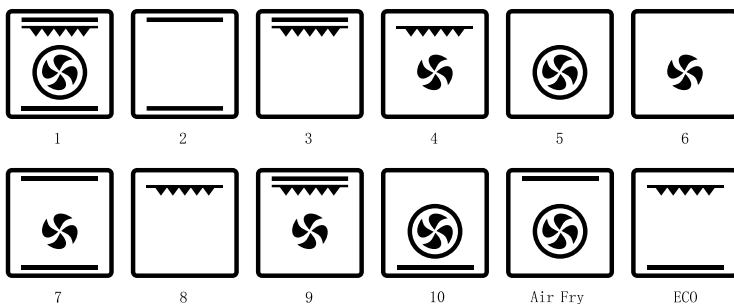

Pic 6: Oven function mode

- ✧ Switching for the first time, for adjustable temperature function level, the default temperature value and temperature icon “°C” flashes. If temperature is not adjustable for that function level, the default clock value and the working time icon “→” flashes.
- ✧ When selecting the function, you can switch to the temperature and working time adjustment by touching the “” button.
- ✧ The temperature value or time can be set by rotating the programming switch KB2.

- ✧ If the working time and temperature are not set, or not touching “▶|” within 10 seconds of completion, the system automatically returns to standby status.
- ✧ The default cooking time, temperature and adjustable temperature range are attached behind.

Note:

1. The grill function setting time range: 0 minutes to 10 hours.
2. When the grilling time is set to 0 minutes, if the button “▶|” is touched at this time, the oven will not work and the system will automatically return to the standby state.

4、Reservation function

- ✧ After setting cooking time and temperature and before touching “▶|” to start-up, touch “☰” to enter to cooking end time setting , cooking end time icon “⌚” will flash, the hour value of the clock position flashes at this time, rotating programming switch KB2 to set the hour time.
- ✧ After setting the hour time, touch “☰” again and enter the minute time setting. At this time, the minute value of the clock position flashes, and the minute time can be set by rotating programming switch KB2.
- ✧ You can use the “☰” to switch hour and minute settings circularly.
- ✧ After cooking end time (hour and minute) setting completed, touch “▶|” to start, system will automatically calculate the grill start time .
- ✧ The oven will display system clock under reservation status. Display effect refers to picture 7.

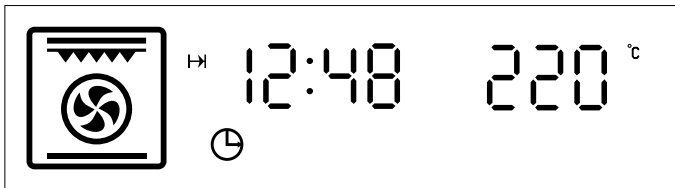

Pic 7: Reservation status display effect

- ✧ Reservation status display: “⌚” reservation icon will display, “⌚” clock icon will display, clock position will display system time, the selected menu will display, temperature will display setting or default temperature.
- ✧ For example, after setting up the function level, grill time and temperature, if you don't use the reservation function, you can touch “▶|” key to start grill function.(refer to picture 8 for the display effect)
- ✧ If more than 10 seconds are not confirmed during setup, the oven will automatically return to standby state.

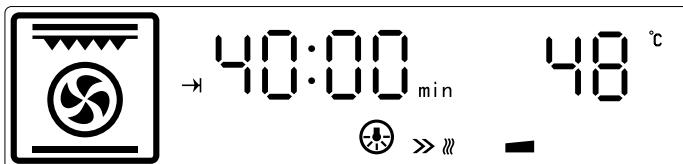

Pic 8: Grill status display effect

- ✧ When the oven works: “→” working time icon will display, clock position will display work countdown time, the selected menu will display, temperature position will display current cavity temperature, oven function start icon “>>” will display, the working status dynamic indicator bar “■” is displayed.
- ✧ When switching to grill time or temperature, the display screen flashes corresponding patterns, and stop flashing after confirm to start. The working time begin to countdown after start up (countdowns by second).
- ✧ When working touch “▶” key will pause the work.
- ✧ In any state, long touch “▶” key will returns to standby status.
- ✧ If the working countdown time is 0, the oven stops working , and the system automatically returns to standby state. At this time, buzzer will sound for 5 minutes.
- ✧ Display temperature range: not lower than 30℃ , and it will show Lo℃ if lower than 30℃.

Note:When the oven under the reservation function,during working process:If the oven door closes,the oven will remain working properly;if the oven door open,the oven will pause working,the display keep flashing.

5、Enquiry function

- (1) Under barbecue state, touch “☰” key once can query system time, the clock position shows the current time of the system, second icon will flash. Re-touch “☰” key or 10s later automatically return to the barbecue time display.
- (2) At the end of the reminder time setting, when under the reservation or barbecue state, touch “☒” can query the alarm remaining countdown. Re-touch “☒” key or 10s later automatically return to its original state. You can query the remaining alarm time and reset the alarm time under standby state, when the alarm countdown time is less than 1 minute, the clock position shows 0: 00.
- (3) In the reservation status, first touch of the “☰” can query the barbecue start time, the clock position shows the barbecue start time, clock value and “→” icon flash. Re-touch “☰” key or 10s later automatically return to the system time display.

6、Alarm function

Touch “☒” key under standby state to enter to alarm function setting, at this time the clock position hour value will flash, minute value will long lit and alarm icon “⚠” keep bright.

- (1) Rotate programming switch KB2 to set the hour time, at this time the hour value is always bright, the value setting range is 0-23;
- (2) Touch “☒” key again, minute value will flash, and hour value keeps bright;
- (3) Rotate programming switch KB2 to set the minute time, at this time the value of the minute is always bright, the setting range is 0-59;
- (4) When the alarm time is set, you can touch “▶” for confirmation, second icon “:” starts to flash, “⚠” icon keeps bright, and it starts to countdown by second, when the time countdown is 00:00, buzzer will sound for 1 minute(1S/time),and alarm clock icon “⚠” will keep flashing display(1S/time), at this time ,press any key can stop the flashing.

🚦 Note:

- 1) During setup, second icon “:” will always bright, alarm clock icon “⌚” will always bright.
- 2) During setup, long touch “▶” key will cancel the current reminder time setting and return to standby state.
- 3) If the alarm function has been set, then alarm clock icon “⌚” should always be displayed when the menu is working, and the reminder time can be queried.

7、Children lock function

- ✧ Lock: press and hold button “▶” and “⊗” simultaneously for 3 seconds at standby or working status, the buzzer sounds for once. That means the oven enters into children lock state. The children lock icon keeps bright.
- ✧ Unlock: press and hold button “▶” and “⊗” simultaneously for 3 seconds at lock status, the buzzer sounds for once, the oven will be unlocked.

🚩 Note:

- 1) Under children lock status, display will be same as normal state, all the keys and knobs operation will be invalid except the unlock button.
- 2) When working at children lock status, you need to unlock first before you want to stop to work.

8、Start/pause/cancel function

8.1 After setting the barbecue function and parameters, tap the "▶" button to start the work; If you tap the "▶" button while the barbecue is paused, you can restart the work.

During the grilling process in the oven, tap the "▶" button once to pause cooking. The flashing time display can be adjusted by rotating KB2 to adjust the working time. For adjustable temperature function, press the "⌚", temperature flashing display that at this time the working temperature of the oven can be adjusted by rotating KB2. The oven working icon "→" flashes and the function icon remains lit; After adjusting, tap the "▶" button to start the work; Zero the barbecue time or long press ▶ to cancel the current cooking.

8.3 When setting the system clock, long press the "▶" button to directly exit the clock setting state and return to standby mode

When setting the oven function, working time, and temperature, long press the "▶" button to directly exit the function setting state and return to standby mode.

During the process of setting the reservation function or after entering the reservation function, long press the "▶" button to directly return to standby mode.

9、Protection function

- A、 Display will show E-1 if sensor is short-circuited or disconnected, buzzer will sound for 10 times continuously, 1S/time (refer to picture 9). Touching “▶” key can return to standby status at this time.

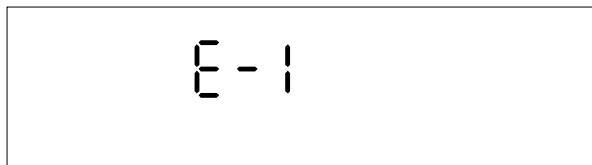

Pic 9: Sensor abnormality alarm display effect

- B、 In addition to the defrost function and ECO function, when the other oven function starts to heat for 5 minutes and the temperature is <35 °C, indicating that the heating element is faulty. The display shows “E-2”, the buzzer sounds 10 times, once every 1 second (display effect as shown in picture 10). At this point, you can return to the standby state by touching the “▶” button.

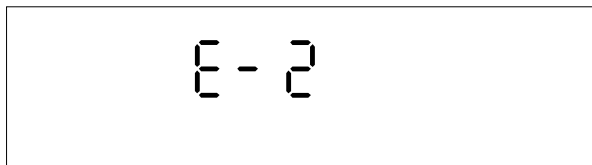

Pic 10: Heat element abnormality alarm display effect

11、 Other instructions

1. Key sound

1.1 Sound for touching the key











1.2 Alarm sound: Heating element faulty sound, sensor fault sound;

1.3 Prompt sound: The temperature reaches the set value, barbecue countdown to 0, the alarm time countdown is zero.

Working mode menu

This appliance has 12 grill functions for choices.

	Icons	Function description
Function 1		Rapid preheating: This mode the inner and outer part of the top heat element and the bottom heat element are both activated to alternately heat circulating, in this mode, also the fan is in operation to provide an even distribution of the heat and shorten the food roasting time, suitable for rapid preheating the oven.

Function 2		Conventional oven (up and base heating): Suitable for grill meat or baking food on one layer.
Function 3		Full Grill: For this mode, all of inside and outside top heating element working, quantity of heat will downward to the food. This mode suit to bake middle or large weight of sausage, bacon, beefsteak, fish and etc.
Function 4		Fan and grill: This method of cooking utilises the top element in conjunction with the fan, which helps to provide a quick circulation of heat.
Function 5		Fan oven: This function is using fan to circulate the heating to bake food. The baking time will be short, so it's economic. Heating fan will be transferred balanced to every rack, avoid mixture taste between different dishes.
Function 6		Defrost: Fan work without heating at room temperature. Defrost time according to quantity and series of food. The defrost time, please refer to the instruction of food packaging label.
Function 7		Fan with lower and upper element: This method of cooking is traditional cooking method, the cooking heat will come from both top and lower elements.
Function 8		Half grill: This method of cooking uses the inner part only of the top element, which directs heat downwards onto the food. This function is suitable for grilling small portions of bacon, toast and meat etc.
Function 9		Fan heating and grill mode: This mode by using top heat element and fan together, to let the inner heating circulate quickly. It is suitable for needing bake food quickly and locking the inner moisture of food, such as beefsteak, hamburger, and some vegetables.
Function 10		Pizza: This mode by using back fan and base heating element, it is suitable for needing base heating and fast heating food.
Function 11		Air frying: This mode by use the upper heating pipe, rear heating pipe and rear high-speed fan to work at the same time, quickly heat and remove the food surface moisture, so that the food forms a crispy appearance, the tender and smooth inside effect.

Function 12		<p>ECO mode: This method of cooking uses the top inner ring and the bottom heating element to control the temperature, making the grilling more energy saving, mainly suitable for large food, oven temperature rises slowly, the heat fully penetrates and the excess heat consumption is reduced.</p>
-------------	-----------------------------------------------------------------------------------	---------------------------------------------------------------------------------------------------------------------------------------------------------------------------------------------------------------------------------------------------------------------------------------------------------

Before using the oven for the first time

Heating up the oven

To remove the new cooker smell, heat up the oven when it is empty and closed. An hour of Top/bottom heating at 250°C is ideal for this purpose. Ensure that no packaging remnants have been left in the cooking compartment.

- 1、 Use the function selector to set Top/bottom heating.
- 2、 Set the temperature selector to 250°C. After an hour, switch off the oven. To do so, turn the function selector to the off position.

Cleaning the accessories

Before you use the accessories for the first time, clean them thoroughly with hot soapy water and a soft dish cloth.

Tips for saving energy

The following information will help you to use your appliance in an ecological way, and to save energy:

- 1、 Use dark coloured or enamel coated cookware in the oven since the heat transmission will be better.
- 2、 While cooking your dishes, perform a preheating operation if it is advised in the user manual or cooking instructions.
- 3、 Do not open the door of the oven frequently during cooking.
- 4、 Try to cook more than one dish in the oven at the same time, whenever possible . You can cook by placing two cooking vessels onto the wire grill.
- 5、 Cook more than one dish one after another. The oven will already be hot.
- 6、 You can save energy by switching off your oven a few minutes before the cooking time. Do not open the oven door.
- 7、 Defrost frozen dishes before cooking them.

How to operate the oven

General information on baking, roasting and grilling

Risk of scalding by hot steam! Take care when opening the oven door as steam may escape.

Tips for baking

- 1、 Use non-stick coated appropriate metal plates or aluminum containers or heat-resistant silicone moulds.
- 2、 Make best use of the space on the rack.
- 3、 It is recommended to place the baking mould in the middle of the rack.
- 4、 Keep the oven door closed.

Tips for roasting

- 1、 Seasoning with lemon juice and black pepper will improve the cooking performance when cooking a whole chicken, turbotton or a large piece of meat.
- 2、 Meat with bones takes about 15 to 30 minutes longer before it is cooked than a roast of the same size without bones.
- 3、 You should calculate about 4 to 5minutes cooking time per centimeter height of the meat.
- 4、 Let meat rest in the oven for about 10 minutes after the cooking time. The juice is better distributed all over the roast and does not run out when the meat is cut.
- 5、 Fish in a fire-resistant dish should be placed on the rack at the medium or lower level.

Tips for grilling

Grilling is ideal for cooking meat, fish and poultry and will achieve a nice brown surface without it drying out too much. Flat pieces, meat skewers and sausages are particularly suited for grilling as are vegetables with a high water content such as tomatoes and onions.

Troubleshooting

The oven may have some abnormal breakdown during working, you can check the fault list before calling to the after-sell service, maybe some breakdown you can repair by yourself.

Normal operation:

When first using the oven, it may have some situation of peculiar smell and smoking for some hours; Open the heating pattern to let the oven burn without anything for 1 hour when use the oven for the first time, then close the heating function, waiting for some time until the oven is cold, open the door and clean the oven.

When oven working, it may have sounds of crisp because of well of metal.

If the heating foods have some moisture, the heating emission hole may blow steam during the working operation.

The fan will start to work after 15 minutes after oven begin to work. Even if the oven is closed, fan will continue to work for 35 minutes.

Please preheat before put food in oven when for baking.

For a long cooking, you can turn off the oven before stop the oven and using the balance heat to finish the cooking.

Malfunction table

Problem	Reason	Suggestion
Oven isn't working	Interrupt electrical current	Check your kitchen light or other appliance if working on
	Breaker malfunction	Check if your breaker are working on
	Forgot to push the timer function	Reset the timer function

Lamp isn't coming on	Lamp have defectiveness	Change for a new lamp
	No electrical current	Check if the oven have electrical current
Oven stop working in a sudden during working	Power interrupt	Check your kitchen light or other appliance whether still working on
	Normal close thermostat protective	Check if the cool fan are working, if yes, need change for a new normal close thermostat
Oven not heating	Not adjust the temperature controller	Set up the temperature
	If this model have timer, you may not set up the time	Set up the timer
	No power	Check the power box
	Heating element was damaged	Change for a new heating element
Water come out from the glass door when working	Door seal is blow-by	Change for a new door seal
	Hinge is not strong enough	Change for a new hinge
Oven stop working but the motor cool still working	Oven working for a long time, so cooling oven need for a long time	Put your hand to the outlet and feel if it is come out for hot air, if yes, it is normal
	Normal open thermostat have a problem	If the air temperature from the outlet is room temperature, need change for a new normal open thermostat

If the problem has not been solved: 1. Separate unit from the mains supply(deactivate or unscrew fuse). 2. Call the after-sales service of your store reseller; Do not attempt to repair the appliance yourself. There are no customer service items inside the appliance.

Baking and grilling tips

Baking tips

- 1、 How to establish whether sponge cake is baked through. Approximately 10 minutes before the end of the baking time specified in the recipe, stick a cocktail stick into the cake at the highest point. If the cocktail stick comes out clean, the cake is ready.
- 2、 The cake collapses. Use less fluid next time or set the oven temperature 10 degrees lower. Observe the specified mixing times in the recipe.
- 3、 The cake has risen tin the middle but is lower around the edge. Do not grease the sides of the spring form cake tin. After baking, loosen the cake carefully with a knife.
- 4、 The cake goes too dark on top. Place it lower in the oven, select a lower temperature and bake the cake for a little longer.
- 5、 The cake is too dry. When it is done, make small holes in the cake using a cocktail stick. Then drizzle fruit juice or an alcoholic beverage over it. Next time, select a temperature 10 degree higher and reduce the baking time.
- 6、 The bread or cake(e.g. cheesecake) looks good, but is soggy on the inside (sticky,

streaked with water). Use slightly less fluid next time and bake for slightly longer at a lower temperature. For cakes with a moist topping, bake the base first. Sprinkle it with almonds or bread crumbs and then place the topping on top. Please follow the recipe and baking times.

7、 The cake is unevenly browned. Select a slightly lower temperature to ensure that the cake is baked more evenly. Bake delicate pastries on one level using Top/bottom heating. Protruding greaseproof paper can affect the air circulation. For this reason, always cut greaseproof paper to fit the baking tray.

8、 The bottom of a fruit cake is too light. Place the cake one level lower the next time.

9、 The fruit juice overflows. Next time, use the deeper universal pan, if you have one.

10、 Small baked items made out of yeast dough stick to one another when baking. There should be a gap of approx. 2 cm around each item. This gives enough space for the baked items to expand well and turn brown on all sides.

11、 You were baking on several levels. The items on the top baking tray are darker than that on the bottom baking tray. Always use 3D hot air to bake on more than one level. Baking trays that are placed in the oven at the same time will not necessarily be ready at the same time.

12、 Condensation forms when you bake moist cakes. Baking may result in the formation of water vapour, which escapes above the door. The steam may settle and form water droplets on the control panel or on the fronts of adjacent units. This is natural process.

Grilling tips

- ▲ When grilling, preheat the oven for approx. 4 minutes, before placing the food into the cooking compartment. Always grill with the oven door closed.
- ▲ As far as possible, the pieces of food you are grilling should be of equal thickness. This will allow them to brown evenly and remain succulent and juicy.
- ▲ Turn the food you are grilling after 2/3 of the time.
- ▲ Do not add salt to steaks until they have been grilled.
- ▲ Add in a little liquid if the meat is lean. Cover the base of the ovenware with approx. 1/2 cm of liquid.
- ▲ Add liquid generously for pot roasts. Cover the base of the ovenware with approx. 1-2 cm of liquid.
- ▲ Place the food to be grilled directly on the wire rack. If you are grilling a single piece, the best results are achieved by placing it in the centre of the wire rack. The universal pan should also be inserted at level 1. The meat juices are collected in the pan and the oven is kept cleaner.
- ▲ When grilling, do not insert the baking tray or universal pan at level 4 or 5. The high heat distorts it and the cooking compartment can be damaged when removing it.
- ▲ The grill element switches on and off continually. This is normal. The grill setting determines how frequently this will happen.
- ▲ When the roast is ready, turn off the oven and allow it to rest for an additional 10 minutes. This allows better distribution of the meat juices.
- ▲ For roast pork with a rind, score the rind in a crossways pattern, then lay the roast in the dish with the rind at the bottom.
- ▲ Place whole poultry on the lower wire rack breast-side down. Turn after 2/3 of the specified time.
- ▲ For duck or goose, pierce the skin on the underside of the wings. This allows the fat to run out.
- ▲ Turn the pieces of fish after 2/3 of the time, whole fish does not have to be turned. Place the whole fish in the oven in its swimming position with its dorsal fin facing upwards.

Placing half a potato or a small ovenproof container in the stomach cavity of the fish will make it more stable.

- ▲ How to tell when the roast is ready. Use a meat thermometer (available from specialist shops) or carry out a “spoon test”. Press down on the roast with a spoon. If it feels firm, it is ready. If the spoon can be pressed in, it needs to be cooked for a little longer.
- ▲ The roast is too dark and the crackling is partly burnt. Check the shelf height and temperature.
- ▲ The roast looks good but the juices are burnt. Next time, use a smaller roasting dish or add more liquid.
- ▲ The roast looks good but the juices are too clear and watery. Next time, use a larger roasting dish and use less liquid.
- ▲ Steam rises from the roast when basted. This is normal and due to the laws of physics. The majority of the steam escapes through the steam outlet. It may settle and form condensation on the cooler switch panel or on the fronts of adjacent units.

Maintenance and cleaning

- The oven should be cleaned after every use. When cleaning the oven the lighting should be switched on to enable you to see the surfaces better.
- The oven chamber should only be washed with warm water and a small amount of washing-up liquid.
- After cleaning the oven chamber wipe it dry.
- Never clean the oven surfaces by steam cleaning.
- The oven cavity should only be cleaned with warm soapy water, using either a sponge or soft cloth. No abrasive cleaners should be used.
- Any stains that may appear on the bottom of the oven will have originated from food splashes or spilt food, these splashes occur during the cooking process. These could possibly be a result of the food being cooked at an excessively high temperature or being placed in cookware that is too small.
- You should select a cooking temperature and function that is appropriate for the food that you are cooking. You should also ensure that the food is placed in an adequately sized dish and that you use the drip tray where appropriate.
- Outer parts of the oven should only be cleaned with warm soapy water, using either a sponge or soft cloth. No abrasive cleaners should be used.
- If you use any form of oven cleaner on your appliance, then you must check with the manufacturer of the cleaner that it is suitable for use on your appliance.
- Any damage that is caused to the appliance by a cleaning product will not be fixed free of charge, even if the appliance is within the guarantee period.
- Do not use cleaning products containing abrasive materials for the cleaning and maintenance of the glass front panel.

Cleaning the oven

No oven cleaner or any other special cleaning agent is required for cleaning the oven. It is recommended to wipe the oven with a damp cloth while it is still warm.

To clean the side walls and oven door

1. Take down left and right side-shelves, method is pushing the bottom of shelves and pull to sides at the same time, push up side shelves and rotate up to level, and pull out the rack.

2. Cleaning left and right sides, order of install is opposite to the order of take down.

Detaching and attaching the oven door

For cleaning purposes and to remove the door panels, you can detach the oven door. Every door hinge has a locking rod, when it is close, door was fixed in place, then the door was not disassembly. If in order to remove down door to open the locking rod, hinge will be locked and would not bite.



When the hinge not locked, it will have a big strength to close in sudden. Make sure locking rod closed all the time, and insure it was open when remove the door.

Remove the door

- Full open the door.
- Fold up the right and left side of locking rod. (picture A)
- Close the door until reach to stop step, hold on both left and right sides of the door, then reclose the door, upward and downward and pull out the door.

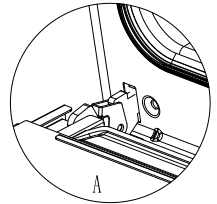

Install the oven door

Accord to the opposite order of door disassembly

- When install oven door, make sure both hinge plug into opening mouth directly.
- Both sides of hinge rabet must bite up each other.
- When open the door, spread down locking rod (picture B)

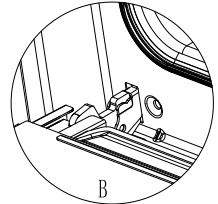

If the door drop accidently or hinges shut up suddenly, do not push you hand in hinges. Please call your after-sell department.

Remove and install door panel

Remove

- Remove oven door, put it on a piece of cloth.
- Using two hand to push the button of the door inner glass bracket, The bracket will eject automatic
- Take away the inner glass and middle glass.

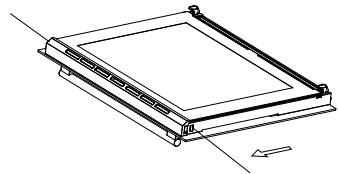

Notice! Dangerous!

If the glass has some scratches, it may lead to crack.

Don't use the glass spatula, acute and corrosive cleaning product or detergent to clean the glass.

Install

- Put the inner glass / middle glass into the door
- Install the door bracket by hand, Notice that the door bracket need to seizing the middle glass .
- Put on the oven door.

Remove and install side shelves

In order to clean sides of oven, you should remove the side shelves to clean the oven
One hand push the side of the cavity , another hand catch the front side of the shelf, pull at the shelf out .

Replacing the oven lamp



If the bulb in the oven Light fails, it must be replaced. Risk of electric Shock!

Switch off the circuit breaker in the fuse box.

- Place a tea towel in the oven when it is cold to prevent damage.
- Unscrew the glass cover by turning it anti-clockwise.
- Replace the bulb with one of the same type.
- Screw the glass cover back in.
- Remove the tea towel and switch on the circuit breaker.

Regular inspections

Besides keeping the cooker clean, you should:

1. Carry out periodic inspections of the control elements and cooking units of the cooker.
After the guarantee has expired you should have a technical inspection of the cooker carried out at a service centre at least once every two years.
2. Fix any operational faults

Carry out periodical maintenance of the cooking units of the cooker.



Caution!

All repairs and regulatory activities should be carried out by the appropriate service centre or by an appropriately authorized fitter.

Environmental note

Note: Before discarding an old appliance, switch off and disconnect it from the power supply. Cut off and render any plug useless. Cut the cable off directly behind the appliance to prevent misuse. This should be undertaken by a competent person.

This appliance is marked according to the European directive 2002/96/EC on Waste electrical and Electronic Equipment (WEEE). By ensuring this product is disposed of correctly, you will help prevent potential negative consequences for the environment and human health, which could otherwise be caused by inappropriate waste handling of this product.



The symbol  on the product or on the documents accompanying the product

indicates that this appliance may not be treated as household waste. Instead it shall be handed over to the applicable collection point for the recycling of electrical and electronic equipment.

Disposal must be carried out in accordance with local environmental regulations for waste disposal. For more detailed information about treatment, recovery and recycling of this product, please contact your local city office or local waste management office.

The packaging materials that we use are environmentally friendly and can be recycled. Please discard all packaging material with due regard for the environment.

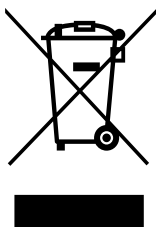

Test dishes































We provide all kinds of recipes and ideal setting for choice here. It will show you which heating type and which temperature are of best suits for your dishes. You can find information about the appropriate accessories and its insertion height, as well as tips on cooking containers and methods of preparation.

Instructions:

- A. The values in the table can always apply to the dishes place in the cold and empty oven. Only pre-heat the oven when it states in the table below. Do not lay the oil-proof paper onto the accessories before pre-heat is completed.
- B. The baking parameters given in Tables are approximate and can be corrected based on your own experience and cooking preferences.
- C. Please use the accessories provided. Before cooking, check that any accessories that are not required are removed from the oven.
- D. Oven glove must be used when removing the accessory or ovenware from the appliance.

Baking and grilling table(Some functions are only available on special models)

Foods	Accessory	Heating function	Rack place	Temperature setting (°C)	Heating time (Mins) Excluding preheating time

Small cake	Bake Pan		3 rd layer	180-200	20-30
Sponge cake	Round model		2 nd layer	165-185	30-45
	Round model		2 nd layer	140-160	30-40
Apple pie	Bake Pan		4 th layer	170-190	45-55
	Bake Pan		4 th layer	155-175	50-60
Pizza	Bake Pan		3 rd layer	190-210	10-20
	Bake Pan		3 rd layer	190-210	10-20
	Bake Pan		3 rd layer	190-210	10-20
Butter biscuit	Bake Pan		3 rd layer	160-180	15-25
	Bake Pan		3 rd layer	140-160	20-30
Bread piece (12piece)	Rack		4 th layer	240-250	2-6
	Rack		4 th layer	240-250	2-6
Sausage	Rack		3 rd layer	190-210	10-20
Ribs	Rack		3 rd layer	190-210	30-40
	Rack		3 rd layer	190-210	20-30
	Rack		3 rd layer	190-210	25-35
	Rack		3 rd layer	190-210	20-30
	Rack		3 rd layer	190-210	20-30
Beef patties	Rack		3 rd layer	200-220	20-30
	Rack		4 th layer	200-220	20-30
Beef steak	Rack		2 nd layer	190-210	20-30
Small Whole chicken (1.2Kg)	Rack		2 nd layer	180-200	60-70
	Rack		2 nd layer	190-210	50-60
	Rack		2 nd layer	180-200	35-45
	Rack		2 nd layer	190-210	55-65
Roast chicken wings	Rack		3 rd layer	190-210	40-50
	Rack		3 rd layer	180-200	25-35
	Rack		3 rd layer	180-200	25-35
	Rack		3 rd layer	180-200	25-35
Whole fish	Rack		2 nd layer	210-230	20-30